



S E R V I C E

Dear NSU-Dealer,

When making use of this Maintenance Manual, please bear the following points in mind:

1. You will be able to recognise the components described more easily if you refer to the illustrations in the Spare Parts List.
2. Unless specifically stated to the contrary, all nuts and bolts have a **right-hand thread**.
3. To carry out the work properly it is necessary to make use of the **special tools** we have developed.
4. If replacement parts are required, use only **genuine spare parts** or **genuine replacement parts**.
5. The **Flat Rate Repair Times** are to be used when estimating for the work, for making up bills, and for checking time sheets.
6. **Abbreviations** are used for the various jobs, i. e.

or Remove and refit engine -- M 01
 Dismantle and assemble engine -- M 02

These abbreviations, used in conjunction with the list of Flat Rate Repair Times, will reduce the time required for writing out repair orders and JOB cards, etc.

London, IX. 1956

With best wishes,
NSU (GREAT BRITAIN) LTD. LONDON

Head Office :

7, CHESTERFIELD GARDENS
CURZON STR., LONDON, W. 1.

Telephone: GROsvenor 4446-7-8
Telex: LON 8701

Telegrams: ENESU
Cables: ENESU LONDON



SERVICE

TECHNICAL DATA

The following technical data refers in general to the standard home market model

QUICKLY
Technical Data / Page 1
Edition IX, 1956**ENGINE**

Engine	- NSU Quickly, unit construction
Cycle	Two-stroke
Cylinder	- Light-alloy, with hard-chromed bore
Bore	- 40 mm
Stroke	- 39 mm
Capacity	- 49 cc
Compression space	- 10.9 cc
Compression ratio	- 5.5:1
Maximum engine speed	- 5200 r. p. m.
Output	- 1.4 h. p.
Compression pressure	- 2.57 kg sq cm (35.5 lb sq in)
Piston clearance	- 0.015 to 0.025 mm (0.0006 to 0.001 in)
Gudgeon-pin diameter	10—0.05 mm
Little-end diameter	10—0.028 mm -0.013 mm
Axial crankshaft play	0.3 mm maximum, otherwise must be corrected
Lubrication	- Petroil mixture
Control of gas flow	By cylinder ports

CARBURETTER

Fuel oil : petrol ratio	- 1:25
Carburetter	- BING Type 1.9 1. Main jet 56. Needle position 2. Needle jet 2.10
Air cleaner	Wet air filter (in frame) with strangler

IGNITION

Type of ignition	Flywheel magneto and lighting generator, 6-volt, 3-watt (0.5 V C 11-1 / W C 11)
Ignition timing	- 2.1 mm or 24° before TDC
Contact-breaker gap	0.2—0.3 mm (0.008—0.012 in)
Spark plug, standard	- Bosch, W 240 T 11
Spark plug electrode gap	0.5 mm (0.02 in)

CLUTCH

Clutch	Multi-plate clutch
Clutch operation	By hand
Clutch spring pressure	47.5 kg (104.7 lb)
Clutch adjuster	On handlebars

GEARBOX

Gearbox	NSU two-speed gearbox built in unit with engine
Gearbox oil capacity	- 135 cc (0.21 pint) SAE 20 in winter SAE 30 in summer
Engagement	- By dogs



SERVICE

TECHNICAL DATA

The following technical data refers in general to the standard home market model.

QUICKLY
Technical Data / Page 2
Edition IX. 1956

Primary drive, engine-gearbox	— By spur gears
Rear drive, gearbox — rear wheel	— By chain
Reduction, engine — gearbox	5.33:1
Gearbox ratios	— 1.88:1 1:1
Reduction, gearbox — rear wheel	— 3:1
Overall reduction ratios	— 30.06:1 15.99:1
Power transmission	Chain 12.7×4.88 mm 112
Chain sprockets	— Gearbox, 12 teeth. Rear wheel, 36 teeth
Axial play of gearbox shafts	— 0.2 mm (0.008 in) (not corrected)

WHEELS AND BRAKES

Tyre size	— Low pressure, 26×2
Tyre pressure	— Front tyre about 1.5 kg sq cm (21 lb sq in) Rear tyre about 1.75 kg sq cm (25 lb sq in)
Rims	— 26×2 well-base rims
Spokes	— Front wheel, L. H., 2.65 mm dia. 263 mm (10 ³ / ₄ in) long Front wheel, R. H., 2.65 mm dia. 235 mm (9 ¹ / ₄ in) long Rear wheel, L. H., 3.00 mm dia. 235 mm (9 ¹ / ₄ in) long Rear wheel, R. H., 3.00 mm dia. 263 mm (10 ³ / ₄ in) long
Leading dimension for spoking up wheels	— Front wheel: 20.5 mm (13 16 in) from outer edge of brake drum to edge of rim Rear wheel: 30.15 mm (13 16 in) from outer edge of chain sprocket to edge of rim
Front brake	— Internal expanding brake
Rear brake	— Internal expanding brake
Brake operation	— Front: By hand Rear: By foot

OTHER DATA

Maximum height	— 960 mm, adjustable (37.8 in)
Maximum width	— 642 mm (25.3 in)
Overall length	— 1895 mm (74.6 in)
Height of saddle	— 780 mm, adjustable (30.7 in)
Frame	— Pressed-steel beam type
Front forks	— Swinging-link springing
Permissible load	— 1 person
Foot rests	— Pedals
Stand	— Central stand
Fuel tank capacity	— 3.1 litres (5 ¹ / ₂ pints), of which 0.4 litres (7 ¹ / ₄ pint) is reserve supply

EQUIPMENT

Electrical equipment	— Flywheel ignition and lighting generator. Headlamp. Rear lamp.
Other equipment	— Tool kit. Luggage carrier. Lock. Tyre pump

Removing Engine from Frame and Replacing

(M 01)

Special tools required:

None.

1. Place the front wheel in a stand. (A suitable stand can be made up very simply in either wood or metal, the design being based on a normal bicycle stand).

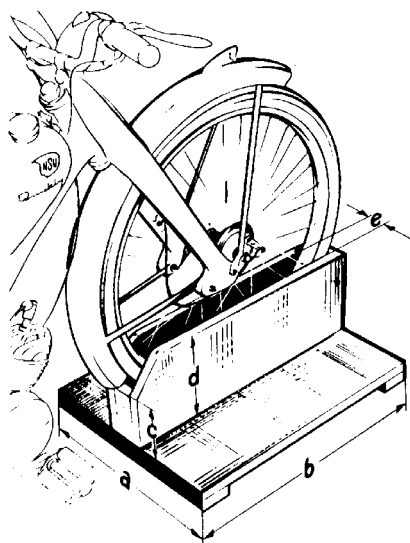

Fig. M 01-1

a 55 cm (22 in) b 60 cm (24 in) c — 15 cm (6 in)
d 20 cm (8 in) e 5 cm (2 in)

2. Close fuel tap.
3. Clean engine externally.
4. Unscrew two slotted screws and take off front left-hand chainguard section. Take care not to lose the spacer tube. This is not fitted in the latest model.
5. Turn chain until spring link is on rear chain sprocket. Undo and remove spring link. Take off chain. Release clutch lever.

6. Loosen silencer clip and bolt on frame. Unscrew nut holding exhaust pipe in cylinder. Remove exhaust pipe and silencer.

7. Knock out left-hand pin on bearing tube for central stand. Push tube out to the right, so that stand is removed from crankcase.

8. After removing the split pin or the locking wire on the brake lever, disconnect the brake rod.

9. Push in the clutch lever. Disconnect the clutch cable and withdraw through slot in left-hand crankcase cover.

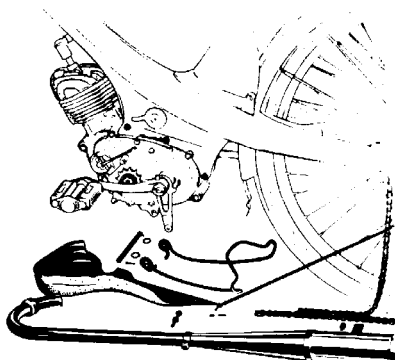

Fig. M 01-2—9

10. Disconnect decompression cable from valve in cylinder head.

11. Unscrew countersunk screw and remove cover from flywheel magneto and lighting generator. Take care not to lose the spacer tube. This also is no longer fitted to the latest model.

12. Disconnect lighting lead from terminal and pull upwards through rubber sleeve.

13. Pull off rubber elbow between carburetter and air filter.

14. Unscrew two nuts (box spanner) and take off carburetter and gasket.



SERVICE

MAINTENANCE MANUAL

QUICKLY
Engine / Page 2
Edition IX, 1956

15. Set gearchange twistgrip to top gear.
16. Push gearchange lever inwards, disconnect cable, and pull through hole in crankcase cover.
17. Remove three mounting bolts and drop engine out of frame.

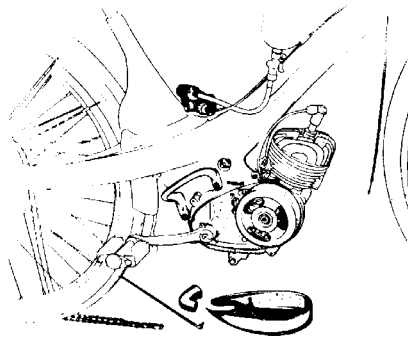

Fig. M 01/10—17

Replacing the engine

18. The engine should be replaced in the frame in the reverse order.

Regarding item 4

Before fitting the two chainguard sections carry out a trial run.

Regarding item 5

Note. Spring link must always be fitted with the spring clip on the outside and with its closed end facing the direction in which the chain travels.

Regarding item 6

On assembly insert a sealing ring before placing the exhaust pipe in the exhaust opening in the cylinder.

Regarding item 17

Make absolutely certain that star washers are placed under the nuts and the heads of the hexagon bolts, so that the bolts cannot loosen in service and so introduce vibration. In the current model, the star washers under the heads of the two bolts that hold the carrying handle have been replaced by locking plates. The star washers fitted to previous models should be replaced by these locking plates if repairs are undertaken.

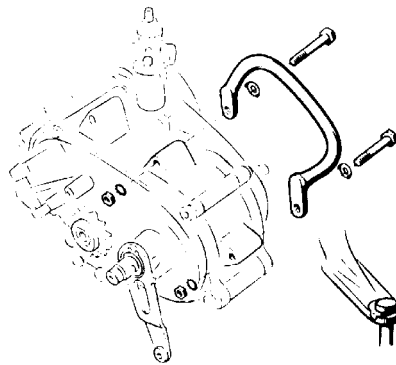

Fig. M 01:17

Stripping the Engine after it has been removed from the Frame

(M 02)

Special tools required

1 Set of Quickly special tools with engine clamping fixture No. 16 91 01 914.

1 Standard commercial rotor extractor (30×1 mm thread) or Fox extractor No. 048 422 007.

1 Assembly stand No. 048 422 000.

1. Secure engine in clamping fixture (16 91 00 901), and place upright.
2. Drain off oil. To do this unscrew drain plug and overflow screw in left-hand crankcase cover.

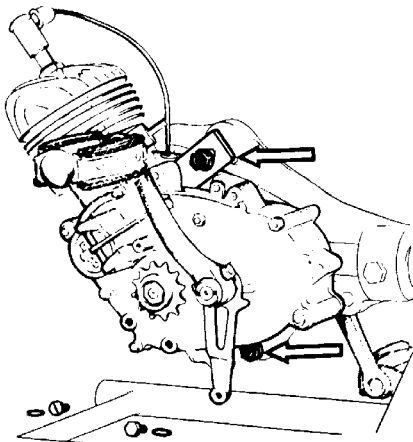

Fig. M 02 1—2

3. Unscrew nuts from both ends of pedal crank spindle using box spanner (16 91 00 902). Remove lock washers.

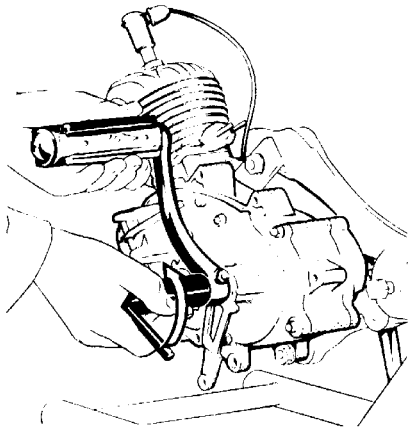

Fig. M 02 3

4. Unscrew nuts and remove washers from crank cotter pins. Knock out cotters with a soft metal punch, and pull off cranks and pedals.

5. Unscrew ignition lead cap. Unscrew sparking plug, and take cap off ignition lead.

6. Unscrew cylinder-head nuts. Remove washers. Take off cylinder head, gasket, and cylinder.

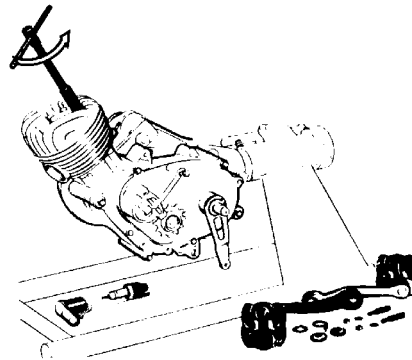

Fig. M 02 4—6

7. Cover cylinder opening in crankcase with a clean cloth. Remove circlips holding gudgeon pin. Carefully warm piston up evenly to a temperature of about 120 °C (250 °F), and push gudgeon pin out with gudgeon-pin punch (16 91 00 903). Remove piston and take off gasket (between cylinder and crankcase).

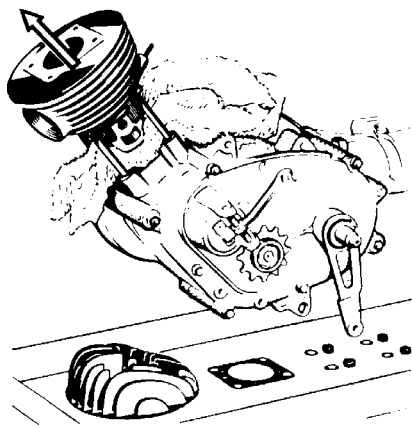

Fig. M 02 7

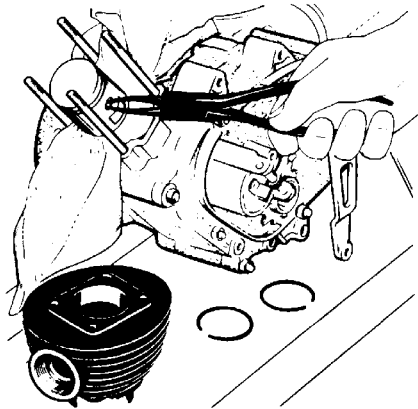

Fig. M 02:7a

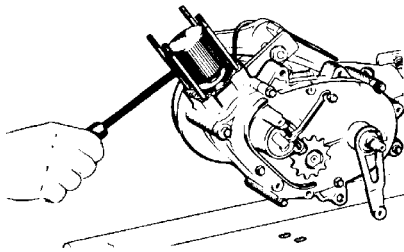

Fig. M 02:7b

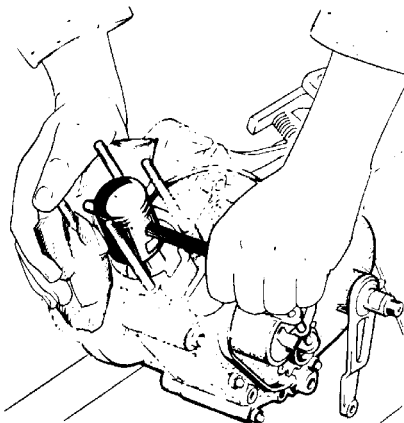

Fig. M 02:7c

8. Turn the engine so that the right-hand side is uppermost.

9. To take off the flywheel (with pole shoes), it is first necessary to loosen the nut which holds it. This nut should, however, not be removed completely, but only unscrewed level with the outside of the flywheel when extractor 16 91 00 904 is used. This will prevent the main shaft from spreading. If extractor 16 91 01 904, which has a brass cap, is used, the nut should be completely removed, and the brass cap placed over the main shaft in its place. This brass cap can also easily be made up locally and used in conjunction with an existing extractor type 16 91 00 904. The latest type of extractor to be supplied, 16 91 02 904, is provided with a threaded bush which screws onto the main shaft. There is no difference in the method of using the extractor. Hold the flywheel with holder (16 91 00 913). Remove the flywheel.

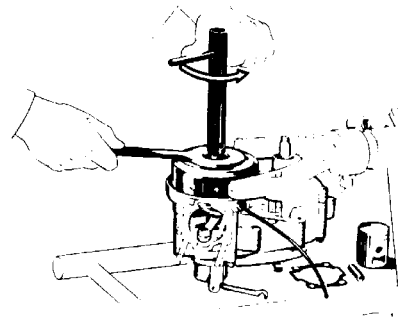

Fig. M 02 9

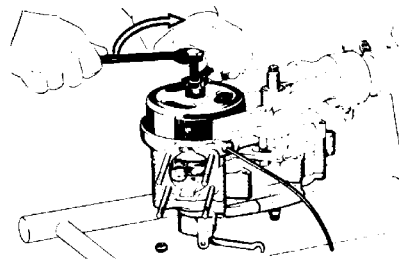

Fig. M 02 9a

10. Unscrew both cheesehead screws on the back plate and the cheesehead screw on the terminal plate. Take off the back plate.

11. Take off the outer circlip and the washer on the gearchange shaft.

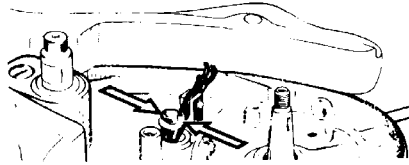

Fig. M 02 11

12. Turn the engine so that the left-hand side is uppermost.

13. Unscrew the nut on the gearbox mainshaft holding the chain sprocket. Hold the chain sprocket while doing this by jamming a rod between the chain sprocket and the clutch casing. Take off the lock washer.

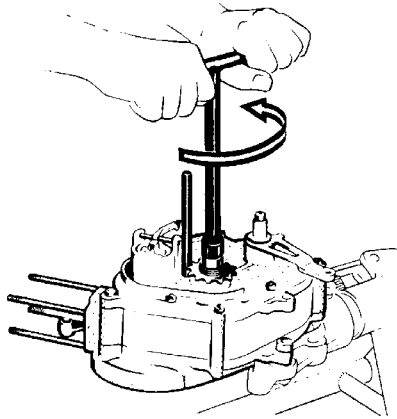

Fig. M 02 12—13

14. Remove the chain sprocket with a normal commercial rotor extractor or the Fox extractor (048 422 007). Take out the key. Remove the rubber sealing ring from the chain sprocket. These sealing rings are not fitted to the latest model.

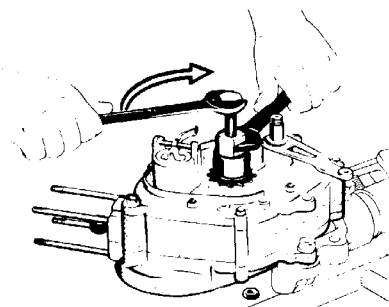

Fig. M 02 14

15. Take the outer circlip off the brake lever. Take off the brake lever.

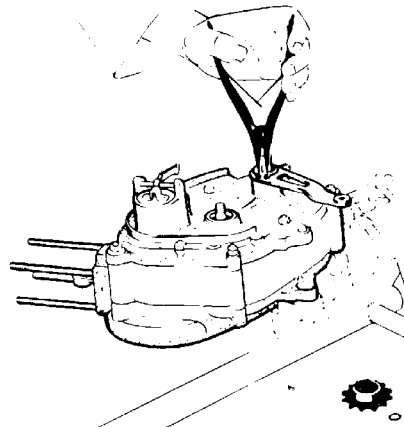

Fig. M 02 15

16. Unscrew 7 nuts with lock washers and 1 bolt with nut and lock washer from left-hand crankcase cover.

Note. Before taking off the cover plate, stick the filler piece (16 91 00 905) in the groove milled for the cotter pin in the pedal crank spindle, so that the two rubber sealing rings in the brake actuating sleeve are not damaged by becoming caught against the edges of the groove. Take off the crankcase cover plate, if necessary loosening it by hitting it with a rubber hammer. Take off the circlip and remove the brake actuating sleeve from the crankcase cover plate. Remove the cover plate gasket.

Do not knock against the top edge of the cover plate (hole for passage of clutch cable), since there is the danger that the cover plate may fracture.

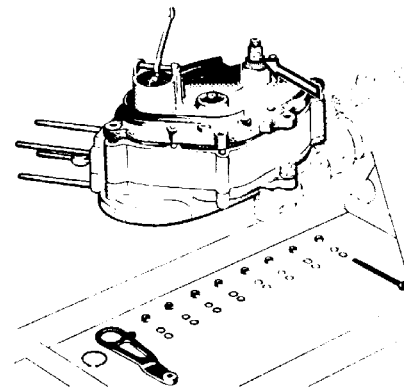

Fig. M 02 16

17. Push the spring clip to one side off the clutch cup by means of a screwdriver.

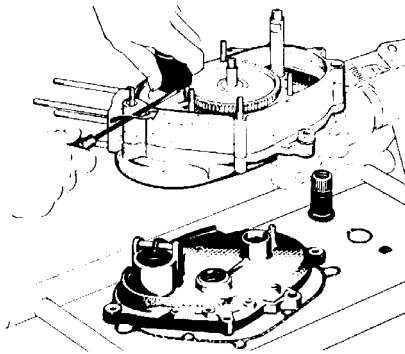

Fig. M 02.17

18. Force off the clutch-operating cup with the levers (16 91 00 908).

Note. Strips of metal or cleaning rags must be placed on the edge of the crankcase under the levers, so that the levers do not damage the sealing surface.

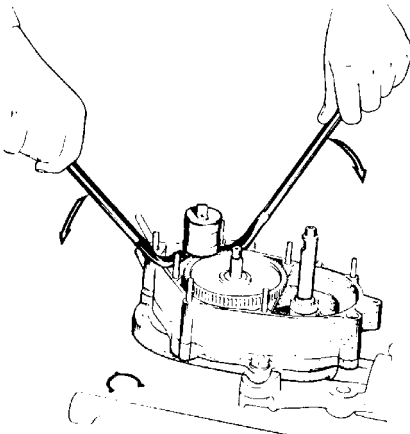

Fig. M 02 18

19. Unscrew a nut and two lock washers from the shaft. Hold the shaft by means of holder (16 91 00 912) placed on the gear pinion, and if necessary by means of a block of wood placed under the big end. Remove the clutch spring with the outer spring cup and the ball bearing which contains the inner spring cup.

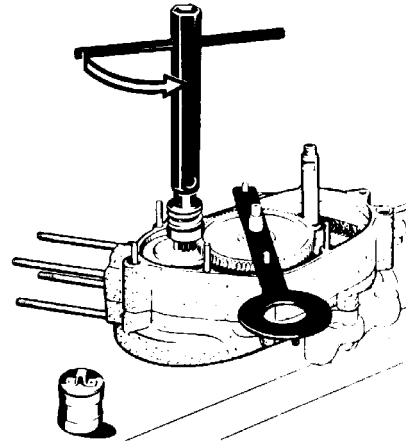

Fig. M 02 19

20. Remove washer and gear pinion from gearbox mainshaft.

Note: Use no force, since the gearchange dogs may be bearing against the layshaft. Turn the pinion slightly to free the dogs.

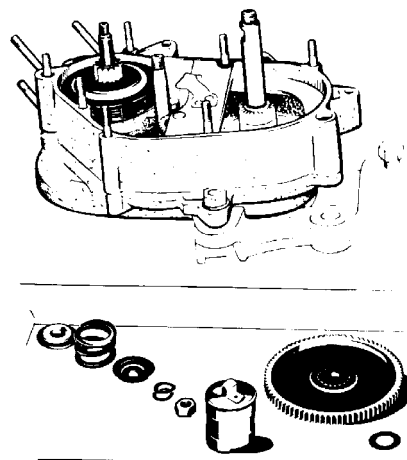

Fig. M 02 20

21. Take off the clutch pinion with the clutch casing, the two lined plates, and the steel plate.

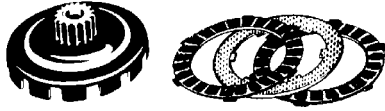

Fig. M 02 21

22. Take the circlip off the left-hand end of the crankshaft, and remove the inner clutch casing with the aid of the levers (16 91 00 908). Remove the rubber sealing ring on the crankshaft by the bearing after the crankshaft has been taken out.

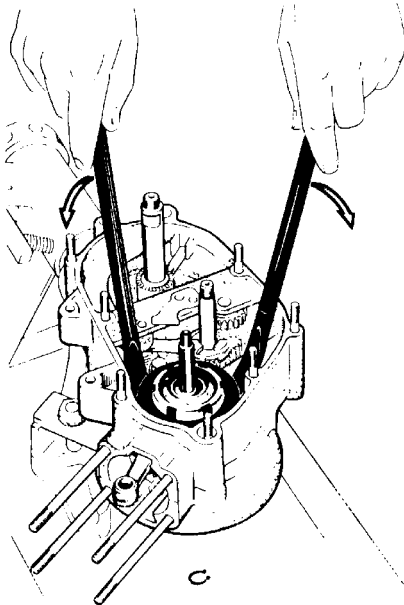

Fig. M 02 22

23. Unscrew the nut and bolt with the two lock washers which are situated roughly in the centre of the crankcase.

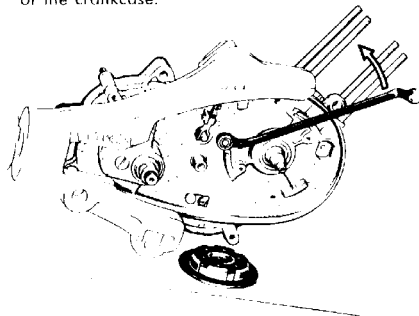

Fig. M 02 23

24. Turn the crankcase so that the left-hand side is uppermost, and take it apart.

25. Take the crankshaft and the gearbox layshaft, together with the thrust washers on either end, out of the right-hand section of the crankcase. Also remove the gearchange fork and its spindle (take the circlip off the fork straight away), the gearchange spring and washer, the driving element together with the sliding spring, the pedal crank spindle with the gear pinion, the gearbox mainshaft with the bottom-gear pinion, and finally the gasket.

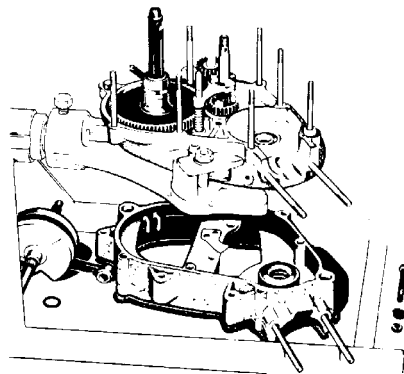

Fig. M 02 24

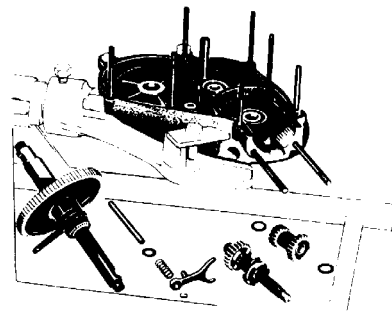

Fig. M 02 25

26. Take the crankcase out of the clamping fixture.

27. Clean and inspect all parts

Assembly of Engine

(M 02)

28. Secure right-hand half crankcase in the clamping fixture with the gearbox side uppermost.

29. Stick the gasket to the crankcase.

30. Measure left-hand and right-hand crankcase sections and the crankshaft and determine the play. The axial play of the crankshaft must not exceed 0.3 mm (0.012 in). The sum of „a“ plus „b“, less „c“, gives the axial play of the crankshaft, „d“. If this exceeds 0.2 to 0.3 mm (0.008 to 0.012 in), washers must be placed on the right-hand end of the crankshaft (without serrations) until the play is reduced to this value. The crankshaft is then fitted. It needs hardly be mentioned that all moving parts must be oiled.

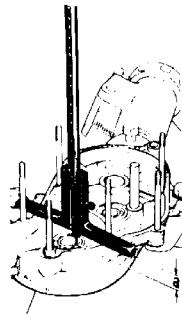

Fig. M 02 30

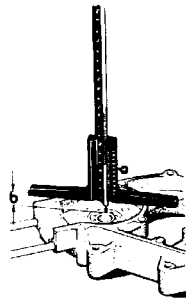

Fig. M 02 30a

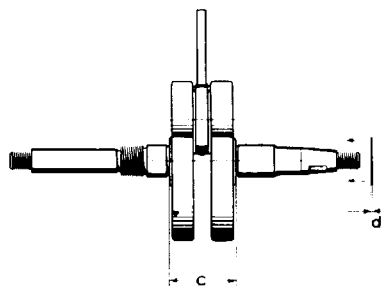

Fig. M 02 30b

$a + b - c = d$ Axial play

31. Place gearbox mainshaft (98 mm \pm 0.05 in long) with bottom gear pinion in right-hand half of crankcase.

Note. The pinion must turn freely on the shaft, and must not bind. (The gearbox mainshaft is now 107 mm \pm 0.05 in long, and is fitted with 1 bush, 1 thrust ring, and 1 thrust washer.)

32. Insert the gearchange spindle from the right-hand side (outside). Fit the spring, gearchange fork, and dogs. Insert the circlip (gearchange fork side). All these components must move freely. (When fitting the gearchange fork, the lug must point downwards.)

33. Fit pedal crank spindle with gear pinion in the crankcase.

34. Place thrust washer on gearbox mainshaft. Insert layshaft and fit the second thrust washer, 10.2 \times 17 \times 1 mm, or a double-thickness thrust washer 10.2 \times 17 \times 2 mm.

35. Cover edge of left-hand crankcase with jointing compound, and when fitting it make absolutely certain that it is properly seated. The two fitted sleeves must be placed in the right-hand crankcase section. Place the left-hand crankcase section on top of the right-hand section. Fit a star washer under the head of the bolt used to hold the two sections together, and then pass the bolt from left to right through the holes provided approximately in the centre of the crankcase sections. Fit a star washer and nut, but **screw up only lightly to avoid distorting the crankcase.** (See section 44.) Place the driving element with the sliding spring on the pedal crank spindle, with the narrow end of the driver against the pinion. Place the eye formed on the spring in the recess provided in the left-hand crankcase section.

36. Push the rubber sealing ring over the serrations on the left-hand end of the crankshaft.

37. Fit the inner clutch casing and insert the circlip. Push the clutch casing down with tool (16 91 00 909) and the axle nut, and push the circlip into place in its groove with the aid of a pair of screwdrivers.

Do not hit the clutch casing.

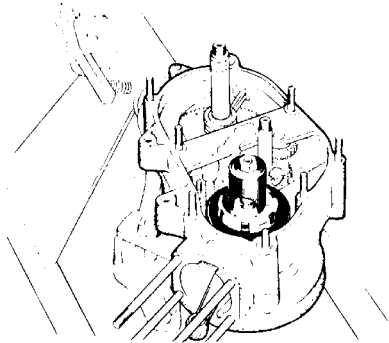

Fig. M 02.37

40. Lay the thrust washer on the gear pinion. Place the ball bearing carrying the inner spring cup, the clutch spring, and the outer spring cup on the left-hand end of the crankshaft. Compress the spring with the assembly bracket (16 91 00 910), fit two spring washers, and tighten up the nut. Hold the shaft by fitting holder (16 91 00 913) to the gear pinion; tighten the nut up **until the clutch slips**.

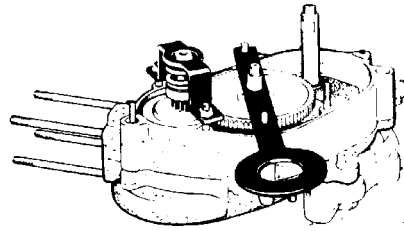

Fig. M 02.40

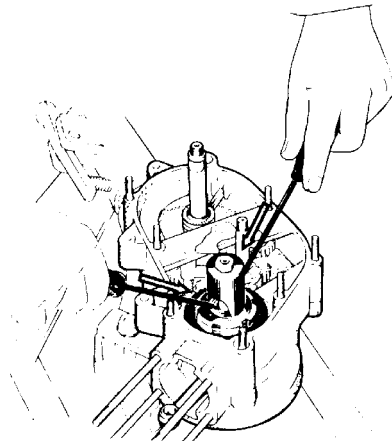

Fig. M 02.37a

41. Remove the bracket, and place the clutch-operating cup over the spring and ball bearing. Use a screwdriver to push the circlip into the cup. Then push down the three lugs with a screwdriver to make sure that the circlip is firmly seated. (See Fig. M 02/17.)

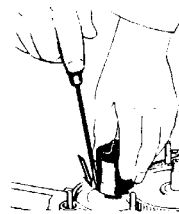

Fig. M 02.41

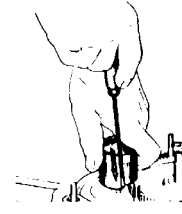

Fig. M 02.41a

38. Lay a lined plate, a steel plate, and another lined plate in the clutch casing, and then fit the outer clutch casing.

39. Push the gear pinion on the gearbox mainshaft. The pinion must be pushed and turned until it slips into place.

42. Stick the gasket to the left-hand crankcase cover with jointing compound.

43. Push in brake actuating sleeve. To prevent the two rubber sealing rings being damaged, the tapered sleeve (16 91 00 906) must be fitted, and the filler piece (16 91 00 905) must be stuck in the groove in the spindle with thick grease.

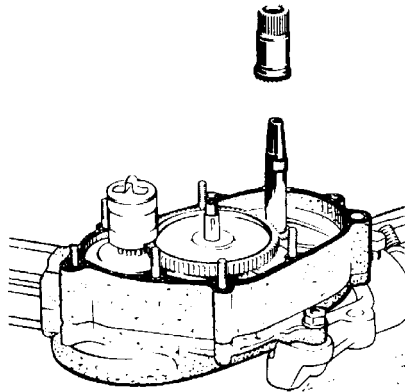

Fig. M 02/43

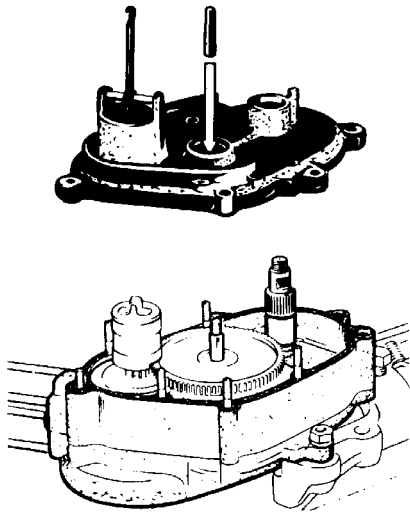

Fig. M 02 43a

44. When fitting the left-hand crankcase cover to the left-hand half of the crankcase, take special care in the case of vehicles later than No. 20 694 21 026 that the edge of the sealing ring in the crankcase cover is not damaged by a sharp edge on the modified gearbox mainshaft. The sleeve (018 110 282) should therefore carefully be pushed into the sealing ring from the outside, with its open end leading, until it rests against the ball bearing. Also place both fitted sleeves in the cover, and then fit this slowly on top of the crankcase. The gearbox mainshaft will force out the sleeve (018 110 282). Secure the cover by screwing a nut with two lock

washers on each of the 7 studs, and by a hexagon-head bolt with nut and two lock washers. Tighten up the nut on the right-hand side of the crankcase (see section 35).

45. Fit a circlip to the brake actuating sleeve, attach the brake lever with the lug pointing to the right, and then fit a second circlip.
46. Place a spring washer on the gearbox mainshaft, followed by the chain sprocket. Fit 1 rubber sealing ring and 2 spring washers, then screw on the nut and tighten up. Hold the chain sprocket by jamming a rod between the sprocket and the clutch casing. Tighten the nut up firmly. In the latest model the seal is on the shaft and not on the chain sprocket, so that the rubber ring is no longer used.

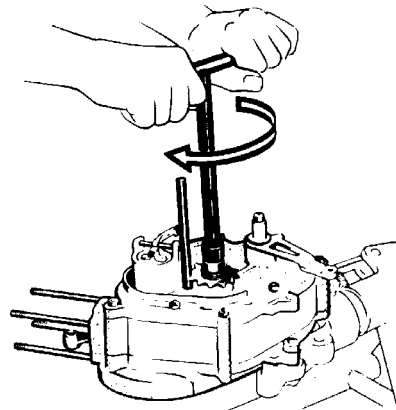

Fig. M 02 46

47. Screw in the oil drain plug.
48. Turn the engine so that the right-hand side is uppermost.
49. Place a washer on the gearchange spindle on top of the lever, and fit a circlip. Check the gearchange mechanism by pushing the top of the lever inwards towards the crankcase (bottom gear). The lever must spring back halfway when released (top gear).
50. Fit the back plate and the ignition cable on the crankcase by means of two cheesehead screws with washers and spring washers. Screw the cheesehead screw and 2 spring washers into the terminal plate. This must be fitted with the cable terminal near the gearchange lever. The felt part must be greased.

51. Fit the flywheel. Insert 2 spring washers and tighten up nut. Hold flywheel with holder (16 91 00 913).
52. Turn the crankcase so that it is upright.
53. Insert the setting pin (16 91 00 911) in the little-end bearing, and align the connecting rod if necessary.



Fig. M 02 53

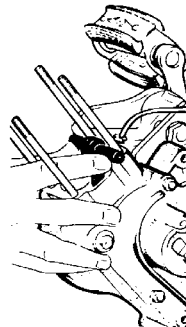

Fig. M 02 53a

54. Place the gasket on the crankcase. Heat the piston up carefully and evenly to a temperature of 120° C (250° F). Insert one circlip and push in the gudgeon pin.
The piston is correctly fitted when the longer edge of the port is at the rear.
A clean cloth should again be placed over the crankcase opening to prevent dirt or foreign bodies falling into the crankcase. Fit the circlip in the piston.

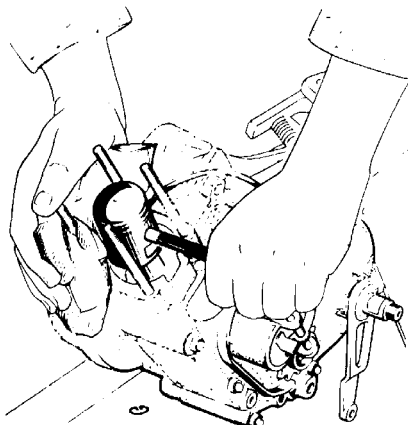

Fig. M 02 54

55. Support the piston on the wooden block. Grip the piston with the piston-ring pliers (16 91 00 907), making certain that the rings fit properly. Carefully push the cylinder over the piston, removing the piston-ring pliers and the wooden block.

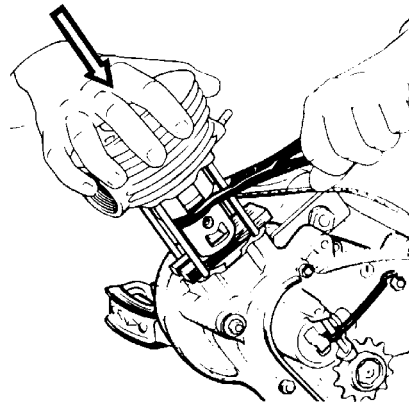

Fig. M 02 55

56. The cylinder is temporarily secured using a pair of spacer tubes to enable the ignition timing to be checked and adjusted as necessary.
57. Time the ignition: contact gap "a" must be 0.2—0.3 mm (0.008 to 0.012 in). Ignition takes place 2.1 mm (0.084 in) before TDC. The break gap of the pole shoe should be 9—12 mm (3/4 to 1/2 in). The arrow on the flywheel shows the direction of rotation; note that the engine turns **anti-clockwise**.

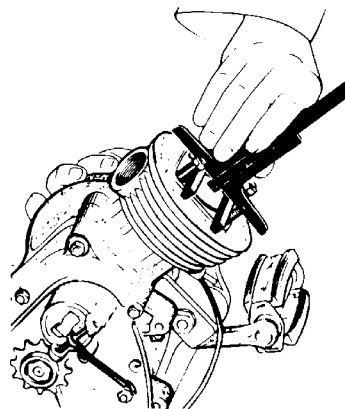

Fig. M 02 57



SERVICE

MAINTENANCE MANUAL

QUICKLY
Engine Page 10
Edition IX, 1956

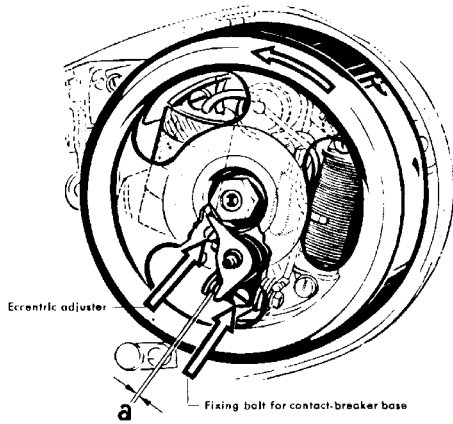

Fig. M 02 57a

a contact gap 0.2—0.3 mm (0.008 to 0.012 in)

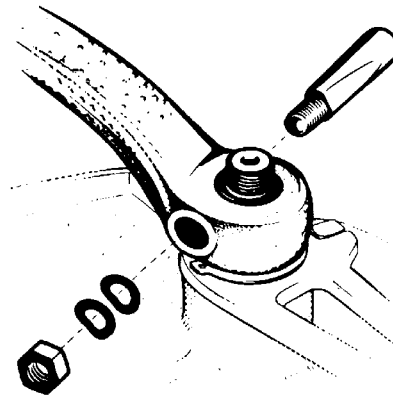

Fig. M 02 60

58. Unscrew both hexagon nuts again, and remove the spacer tubes. Fit the cylinder-head gasket. **Make certain opening for decompression passage is not blocked.** Fit cylinder head and tighten nuts.

59. Unscrew oil filler plug on crankcase by right-hand end of pedal crank spindle, and fill with 120 cc (0.21 pint) of SAE 30 oil in summer or SAE 20 oil in winter. The hole drilled in the front portion of the left-hand crankcase cover plate, in which a slotted bolt is screwed, enables the oil level to be checked. Replace the oil filler plug.

60. **Fit the right-hand crank with pedal first**, pushing it on the spindle and securing it with the cotter pin. **Then fit the left-hand crank**, which is also secured by means of a cotter pin. The two cranks must be displaced by 180°. Note that the left-hand pedal is marked with an „L“, on the right-hand pedal with an „R“. Screw the nuts on either must be placed against the machined boss on the special spanner (16 91 00 902).

Note. The nut and washer on the cotter pin must be placed against the machined boss on the pedal crank. The crank spindle must not be turned until both pedal cranks have been firmly secured.

61. Screw in sparking plug. Push rubber sleeve over ignition cable, fit cap, and place on sparking plug.

62. Take the engine out of the clamping fixture.



Front Wheel - Removal and Fitting

(F 01)

1. Disconnect lower end of front brake cable. Loosen both pinch bolts on the pivoted links. Unscrew nut from pin axle, and knock out axle.
2. Replace in the reverse order. Note that the two spacer rings are placed on the left-hand bearing cone. (If a speedometer is fitted, these two rings are not required).

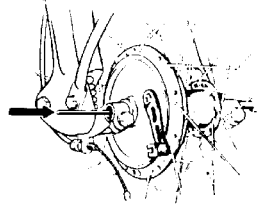

Fig. F 01 c



Fig. F 01

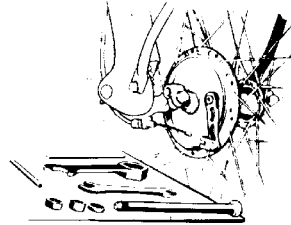

Fig. F 01 d

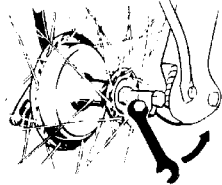

Fig. F 01 a



Fig. F 01 e

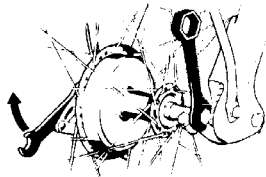

Fig. F 01 b



SERVICE

MAINTENANCE MANUAL

QUICKLY

Frame Page 2

Edition IX, 1956

Rear Wheel - Removal and Fitting

(F 02)

1. Disconnect brake rod from rear-brake cam lever. Unscrew axle nut, and pull out axle. Remove chain from rear chain sprocket (on hub), and drop rear wheel out downwards.
2. Replace in the reverse order. Re-adjust the chain tension by means of the chain adjusters, taking care to see that the rear wheel fits squarely in the forks.

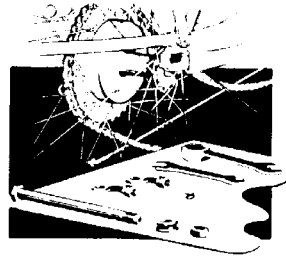

Fig. F 02 b

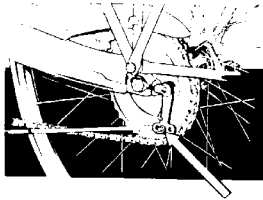

Fig. F 02

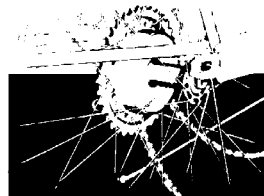

Fig. F 02 c

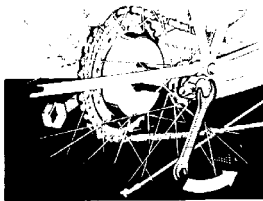

Fig. F 02 a



Fig. F 02 d

Ball Bearing Cup or Seal in Hub - Removal and Fitting

(F 03)

1. Remove front wheel (see F 01)
Remove front brake back plate (see F 04)
or
Remove rear wheel (see F 02)
Remove rear brake back plate (see F 05)
2. Unscrew the left-hand bearing cone (hold with an open-ended spanner), then knock out the complete right-hand cone with a flat punch. Use a normal commercial type of extractor with an expanding sleeve to withdraw the two bearing cups. On the left-hand side the sealing ring will be withdrawn with the bearing cup.
3. Replace in the reverse order,

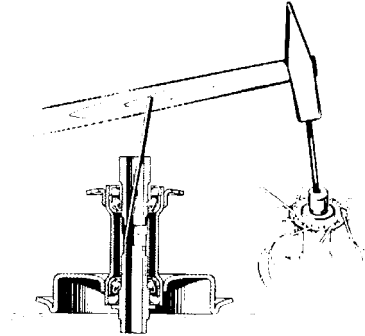

Fig. F 03 a

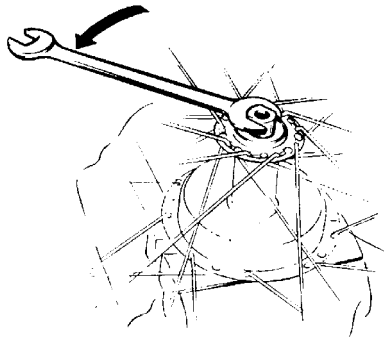

Fig. F 03

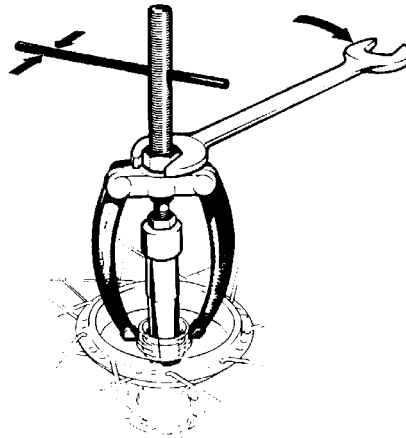

Fig. F 03 b

Front Brake Back Plate - Removal and Fitting

(F 04)

1. Remove front wheel (see F 01)
2. Unscrew hexagon nut on brake back plate (hold by grasping the brake cam lever). Hold the back plate by the brake cam lever, and hit the right-hand bearing cone a few times with a rubber hammer. The brake back plate can then easily be removed.
3. Replace in the reverse order.

Rear Brake Back Plate - Removal and Fitting

(F 05)

1. Remove rear wheel (see F 02)
2. Take circlip out of hub. For remaining operations, see F 04.
3. Replace in the reverse order.

Renew Brake Linings

(F 08)

1. Remove front wheel (see F 01)
Remove front brake back plate (see F 04)
or
Remove rear wheel (see F 02)
Remove rear brake back plate (see F 05)
2. Disconnect return spring hooked on to brake-cam ends of brake shoes by means of a sharp-nosed pair of pliers. Take off the brake shoes. Cut off the rivet heads on the inside of the brake shoes, and knock the rivets out with a suitable punch. Take off the brake linings.
3. When riveting on the new linings, insert and clench over the central rivets first. Make certain that the brake linings fit properly over the whole of the brake shoes.
4. Fit the brake shoes in the following manner: — Hook one return spring into both brake shoes (pivot end), and hook the second return spring into the left-hand brake shoe. Fit the left-hand brake shoe in place, and then fit the right-hand brake shoe. Hook the other end of the second spring into place in the right-hand brake shoe with a sharp-nosed pair of pliers.

Front Forks - Removal and Fitting

(F 20)

1. Remove front wheel (see F 01)
2. Unscrew knurled bolt, and take off headlamp rim and reflector. Disconnect leads and pull out through rubber grommet together with protective sleeve. Unscrew hexagon cap on fork stem and remove lock washer. Unscrew two hexagon-head bolts with nuts and star washers on the forks and handlebar bracket, and lay the complete handlebars on the tank or frame (place a cloth underneath to prevent damage to the paintwork). Take off the headlamp. Unscrew the lock nut on the fork stem and drop the forks downwards clear of the steering head. Pull the protective sleeve and the two cables out of the forks.
3. If the forks are to be changed, the front mudguard will have to be removed (see F 26).
4. Replace in the reverse order.

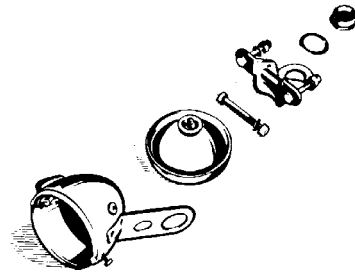

Fig. F 20 a

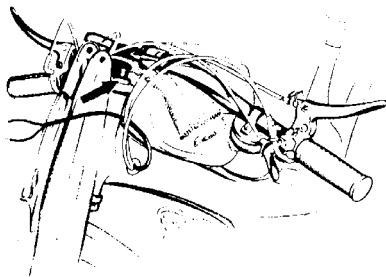

Fig. F 20

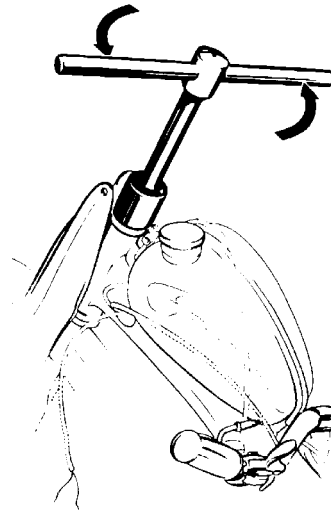

Fig. F 20 b



SERVICE

MAINTENANCE MANUAL

QUICKLY

Frame Page 5

Edition IX, 1956

Steering-Head Cones, Cups, and Balls - Removal and Fitting (F 21)

1. Remove front wheel (see F 01)
Remove front forks (see F 20)
2. Take off the cover and the upper steering-head cone with balls, and also the balls out of the lower race. Knock the upper and lower head races out of the steering head with a suitable punch. If the lower cone is to be replaced, it must be forced off the fork stem by hitting it with a flat punch, or must be levered off with a pair of screwdrivers.
3. Assembly: After pressing the lower cone on to the fork stem with a suitable tube and fitting the two head races into the steering head, place 21 balls (5 mm dia.) bedded in grease in each race, and then fit the upper cone and cover. Insert the forks carefully from underneath, and screw on the lock nut. The head bearings should then be adjusted so that there is no play in the forks, but that the weight of the forks (preferably with the front wheel fitted) will prove sufficient to swing them right round to full lock.

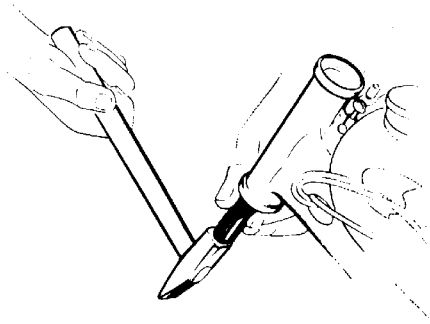

Fig. F 21 b

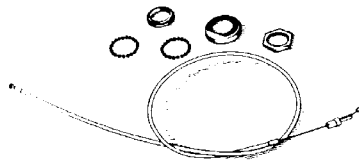

Fig. F 21

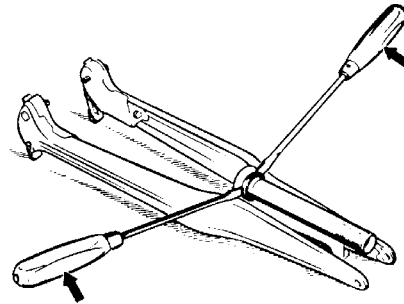

Fig. F 21 c

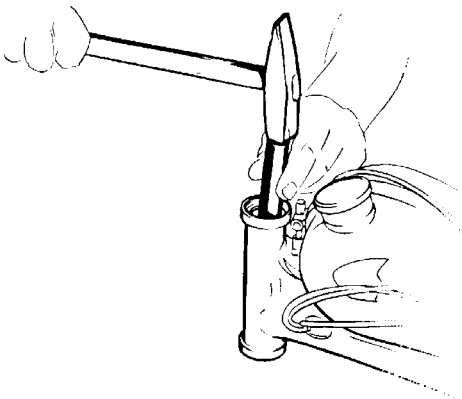

Fig. F 21 a



SERVICE

MAINTENANCE MANUAL

QUICKLY

Frame Page 6

Edition IX, 1956

Pivoted Links (Left-Hand and Right-Hand) - Removal and Fitting (F 24)

1. Remove front wheel [see F 01]
2. Unscrew nuts on left-hand and right-hand pivot bolts and knock out the bolts. On the right-hand pivoted link unscrew the brake cable adjuster. Unscrew hexagon-head bolts screwed into threaded bushes in ends of fork springs on either side, and take pivoted links with springs out of the forks.
3. Replace in the reverse order. Adjust the brake cable.

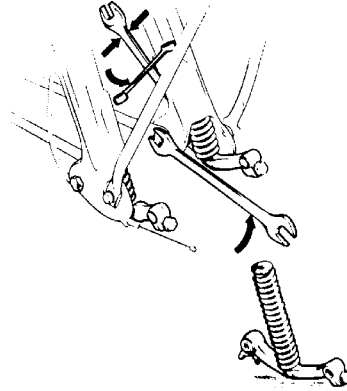

Fig. F 24

Replacing Bushes in Pivoted Links (F 25)

1. Remove front wheel (see F 01)
Remove pivoted links (see F 24)
2. Knock out old bearing bushes with a suitable punch and press in new. Ream bush out to 11.02 mm dia., or in the case of machine 122280 131361 and later, fitted with the new pivoted links, to 12.02 mm dia.
3. Replace in the reverse order.

Front Mudguard - Removal and Fitting (F 26)

1. Remove front wheel (see F 01)
2. Unscrew nut on forks (centre of mudguard). After unscrewing the two hexagon-head bolts with lock washers and self-locking nuts on the forks, the mudguard can be removed.
3. Replace in the reverse order.

CONTROLS AND CABLES

Handlebars (and Fittings) - Removal and Fitting (F 40)

1. Disconnect clutch, brake, decompression, throttle, and gearchange cables (see F 50, F 51, F 52, F 53, F 54). Unscrew two cap nuts with lock washers from hexagon-head bolts on handlebar clamps. Remove handlebars, bending clamps up as necessary.
2. Replace in the reverse order.

Handlebar Bend - Stripping and Assembly (F 41)

1. Remove throttle and gearchange twistgrips (see F 40, F 45, F 46).
2. Assemble in the reverse order.

Brake or Clutch Lever - Removal and Fitting (F 44)

1. Disconnect brake and clutch cables from the levers. Unscrew both 5-mm nuts with spring washers and both pivot bolts from the twistgrip bodies. Take off levers.
2. Replace in the reverse order.

Throttle Twistgrip - Removal and Fitting (F 45)

1. Push rubber sleeve clear of adjuster. Slacken lock nut on adjuster, and screw cable adjuster on carburetter in as far as possible. Unscrew carburetter cap, and pull cable and throttle slide out of carburetter. Disconnect the cable. Unscrew slotted screw in twistgrip body. Pull complete twistgrip off handlebars. Disconnect cable from twistgrip.
2. If the twistgrip is to be replaced, the front brake cable must be disconnected from the hand lever and the brake cam lever, and the hand lever removed from the twistgrip by unscrewing the nut and the pivot bolt.
3. Replace in the reverse order.

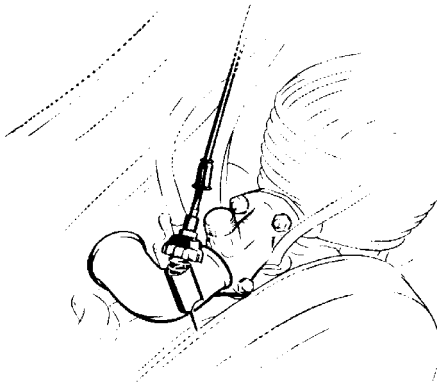

Fig. F 45

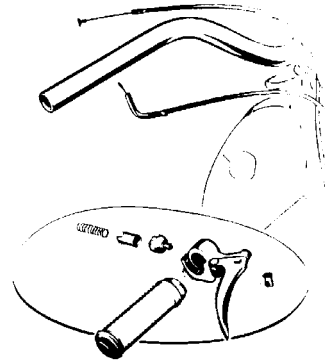

Fig. F 45 a

Gearchange Twistgrip - Removal and Fitting

(F 46)

1. Disconnect decompression cable from valve by lightly pressing thrust plate with a screwdriver. Unscrew slotted screw in twistgrip body, and pull complete twistgrip off handlebars; disconnect gearchange cable. When taking out the nipple, lift the rubber sleeve on the twistgrip slightly with a thin screwdriver.
2. To make certain that the nipple is properly seated on assembly, unscrew the slotted screw and take off the cover from the flywheel magneto.
3. If the gearchange twistgrip is to be replaced, the decompression cable must be disconnected as described in section 1. Unscrew the slotted screw on the decompression lever. Completely unscrew the slotted screw on the twistgrip body, and remove the decompression cable with the lever and bracket. Screw the slotted screw in again. Take off the chainguard. Push the clutch lever in and disconnect the cable; also disconnect the cable from the hand lever on the handlebars. Loosen the lock nut on the adjuster, and unscrew the adjuster on the twistgrip; disconnect the cable. Unscrew the pivot bolt on the twistgrip body and remove the clutch lever. Unscrew the slotted screw on the twistgrip body, and take the complete twistgrip off the handlebars; disconnect the gearchange cable.
4. Replace in the reverse order.

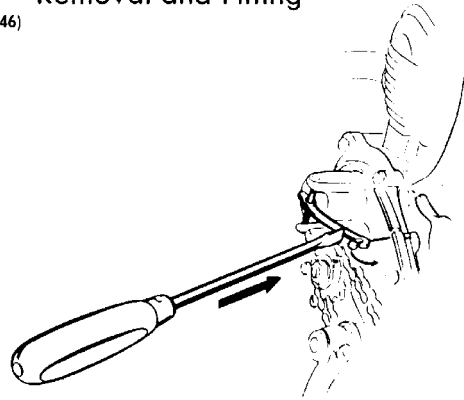

Fig. F 46 a

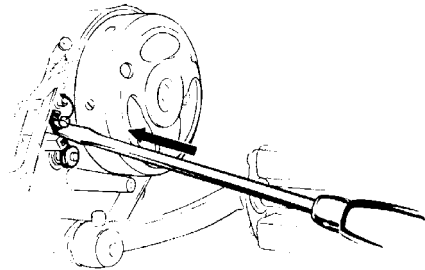

Fig. F 46 b

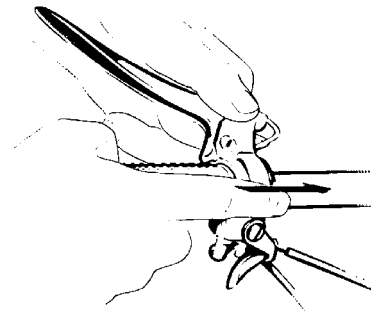

Fig. F 46 c

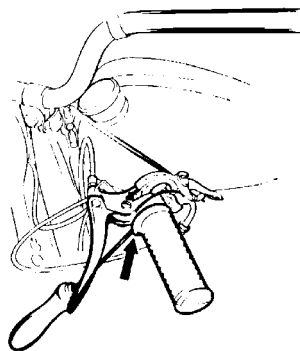

Fig. F 46

5. When removing and fitting the cover for the flywheel magneto, remember that a spacer tube is used. This tube is not required for vehicles after No. 78001/82783.
6. Also remember the spacer tube when removing or fitting the front section of the chainguard. This tube has not been fitted after machine No. 62701/66990.



Sleeve on Twistgrip - Removal and Fitting

(F 47)

1. Push a thin screwdriver a fair distance down between the sleeve and the twistgrip, and lift the sleeve. Squirt petrol between sleeve and twistgrip with an oil can, and pull the sleeve off.
2. Assembly: Moisten the twistgrip with petrol, and push the sleeve on.

Clutch Cable - Removal and Fitting

(F 50)

1. See F 46, section 3.
2. Twist a piece of wire (about 1.5 metres - 5 ft long) round the lower nipple and pull the old cable out in an upward direction. Then twist the wire, which is protruding through the rubber grommet on the frame, round the lower nipple of the new cable, and pull this back through the frame.
3. Assemble in the reverse order (see F 46, section 3).

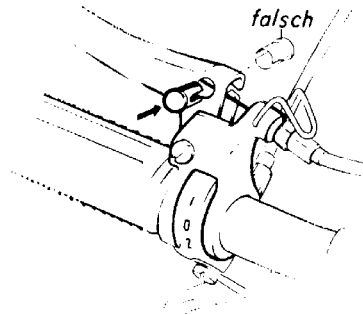

Fig. F 50

falsch incorrect

Brake Cable - Removal and Fitting

(F 51)

1. Take off chainguard (see M 16)
2. Disconnect nipple at lower end of brake cable. Screw the adjuster out of the right-hand pivoted link. Bend up the cable clip inside the right-hand fork member. Disconnect the cable from the lever on the handlebars, and pull it out downwards.
3. Replace in the reverse order. Do not forget to bend down the clip on the forks.

Decompression Cable - Removal and Fitting (F 52)

1. Push down the decompression valve with a screwdriver. Take the spring off the thrust plate and disconnect the cable at the cylinder head. Unscrew the set screw in the solderless nipple (upper end of cable), and pull out the cable.
2. Assembly: Secure the upper end of the cable in the solderless nipple (allow the end of the cable to project about 7 mm — 3/8 in). Fit the spring on the thrust plate down by the valve, and push the nipple down into the cylinder head with a screwdriver. There should be about 0.5 to 1.0 mm (0.02 to 0.04 in) play in the cable.

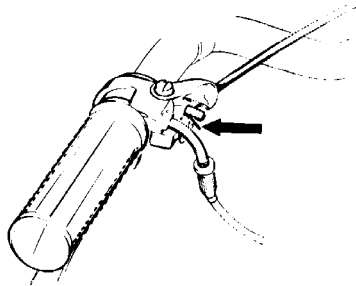

Fig. F 52

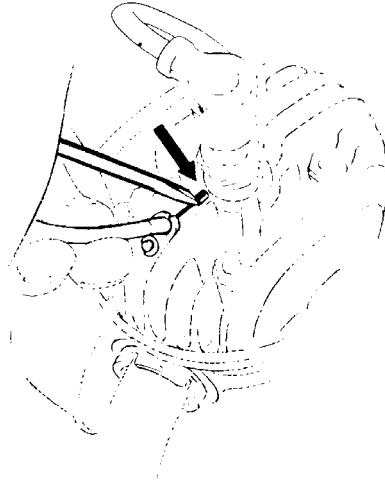

Fig. F. 52 a

Throttle Cable - Removal and Fitting (F 53)

1. Loosen nut on adjuster, and screw adjuster right in. Unscrew cap from carburetter, and take out cable and throttle slide. Disconnect the cable. Unscrew the slotted screw on the body of the twistgrip. Pull the complete twistgrip off the handlebars, and disconnect the cable from the twistgrip. To take off the cable, loosen the strap holding the fuel tank slightly, so that the cable can be pulled out under the two rubber blocks.
2. Replace in the reverse order.

Gearchange Cable - Removal and Fitting (F 54)

1. Take cover off flywheel magneto (see M 50).
2. See F 46, sections 1, 2, and 3.
3. Disconnect cable from gearchange lever. Attach a piece of wire (about 1.5 metres — 5 ft long) firmly to the lower nipple, and pull old cable with the wire attached **out in an upward direction**.
4. Assembly: Attach the lower nipple of the new cable to the wire, and pull it **downwards through the frame**. The remaining operations are then carried out in the reverse order. (See F 46, sections 1, 2 and 3).

FRAME

Frame - Removal and Fitting

(F 60)

1. Remove engine (see M 01)
Remove rear wheel (see F 02)
Remove luggage carrier (see F 75)
Remove rear mudguard (see F 62)
Remove saddle (see F 72)
Remove fuel tank (see F 80)
Remove front forks (see F 20)
2. When removing the forks it is advisable to hang the frame up.
Attach wires to the ends of the leads and cables etc., (as described in F 50 and F 54), and pull these out of the frame when taking off the handlebars.
3. Replace in the reverse order.

Rear Mudguard - Removal and Fitting

(F 62)

1. Remove rear wheel (see F 02)
Remove luggage carrier (see F 75)
Remove rear lamp (see E 09)
2. Bend up five clips on the rear mudguard and on the stays, and pull out the lead for the rear light as far as the main frame member. Unscrew the hexagon-head bolt on the rear chainguard and the central stay. Unscrew two hexagon-head bolts with nuts and lock washers on the front mounting (cover plate), and take off mudguard.
3. Replace in the reverse order.

Exhaust System - Removal and Fitting

(F 70)

1. See M 01, section 6.

Pivoted Saddle - Removal and Fitting

(F 72)

1. Loosen the expander bolt a couple of turns. Lay a large screwdriver or a flat bar on the head of the bolt, and hit it with a hammer so that the nut is freed and the saddle can be removed.
2. When fitting the saddle, take care that the saddle column is not pulled out **beyond the marks**. Tighten the expander bolt up well.

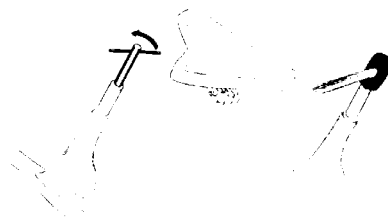

Fig. F 72

Centre Stand - Removal and Fitting (F 74)

1. See M 01, section 7.

Luggage Carrier - Removal and Fitting (F 75)

1. Remove tyre pump. Unscrew two hexagon-head bolts with nuts and spring washers from the beam on either side and hexagon-head bolt from top of rear mudguard, and take off luggage carrier.
2. Replace in the reverse order.

Fuel Tank - Removal and Fitting (F 80)

1. Remove fuel pipe from tap, and unscrew nut from strap. Hinge strap up, and take off fuel tank.
2. If a new fuel tank is to be fitted, unscrew the tap and take off cap and seal. Also remove the two rubber blocks. Replace in the reverse order.
3. Replace in the reverse order.

Fuel Tap - Removal and Fitting (F 82)

1. Unscrew fuel pipe from fuel tap. Lean the machine over to the left and unscrew union nut holding tap to tank.
2. Replace in the reverse order.

Pedals - Removal and Fitting (F 85)

1. Left-hand pedal is marked „L“ (left-hand thread), and right-hand pedal is marked „R“ (right-hand thread). Unscrew pedals with a spanner, and remove.
2. Replace in the reverse order.



SERVICE

MAINTENANCE MANUAL

QUICKLY
Frame Page 13
Edition IX, 1956

ELECTRICAL INSTALLATION

Rear-Light Lead - Removal and Fitting (E 02)

1. Unscrew knurled bolt on headlamp, and take off headlamp rim and reflector. Disconnect both leads, and pull out with the protective sleeve. Unscrew slotted screw on rear lamp, take off cap, disconnect lead, and pull through mudguard. Bend up five clips on rear mudguard and stay, and take lead off as far as frame. Take the cover off the flywheel magneto by unscrewing the slotted screw, and disconnect the lead from the terminal. (It is necessary to disconnect all the leads in this way, since it is difficult to pull one lead on its own through the frame and the protective sleeve.)
2. Firmly twist or solder a piece of wire (about 1.5 metres - 5 ft long) to the lower end of each lead. Pull both leads and the protective sleeve up through the frame and out of the top.
3. Assembly: Connect the new lead to the wire, and pull it through into the frame with the protective sleeve. The remaining operations are then carried out in the reverse order. (The rear-light lead should be connected to the terminal with the red markings in the headlamp.)

Wiring Diagram
(3-watt equipment)

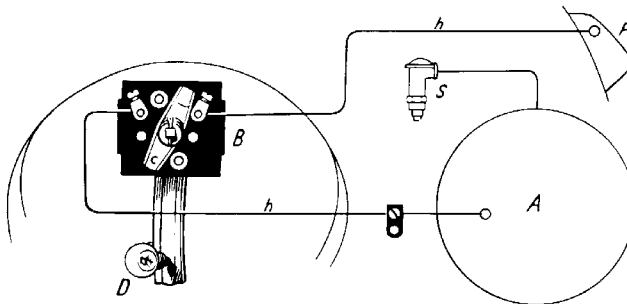

- A - Flywheel magneto and lighting generator
- B - Switch plate
- F - Rear lamp
- S - Sparking plug
- h - grey

Wiring Diagram
(17-watt equipment)
for export only

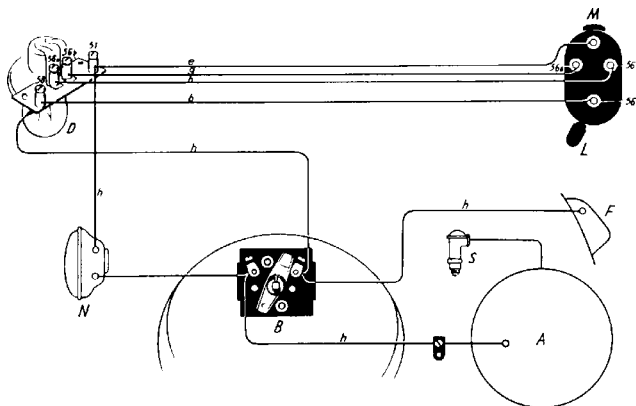

- A - Flywheel magneto and lighting generator
- B - Switch plate
- D - Double-filament bulb
- F - Rear lamp
- L - Dipper switch
- N - Horn
- S - Sparking plug
- b - red
- e - white
- g - green
- h - grey

Lighting Leads - Removal and Fitting

(E 04)

1. See E 02.

Rear Light - Removal and Fitting

(E 09)

1. Unscrew slotted screw and take off rear lamp. Disconnect lead. Unscrew nut with lock washer on mudguard, and take off bulb socket.
2. Replace in the reverse order.

Headlamp Glass or Reflector - Removal and Fitting

(E 12)

1. Unscrew knurled bolt on headlamp and take off rim and reflector. Remove three spring clips on reflector, and take off reflector. Take out glass and sealing ring.
2. Replace in the reverse order.

Headlamp - Removal and Fitting

(E 13)

1. Unscrew knurled bolt on headlamp, and take off rim and reflector. Disconnect both leads. Unscrew hexagon cap on fork stem and take off lock washer. Unscrew two hexagon-head bolts with nuts and star washers on forks and handlebar bracket, and lay the complete handlebars on the tank or frame, (place a cloth underneath to prevent damage to the paintwork). Take off the headlamp.
2. Replace in the reverse order.

CARE and MAINTENANCE

Grease vehicle

(W 01)

1. See Instruction Book.



SERVICE

SPECIAL TOOLS FOR QUICKLY

QUICKLY
Special Tools Page 1
Edition IX, 1956

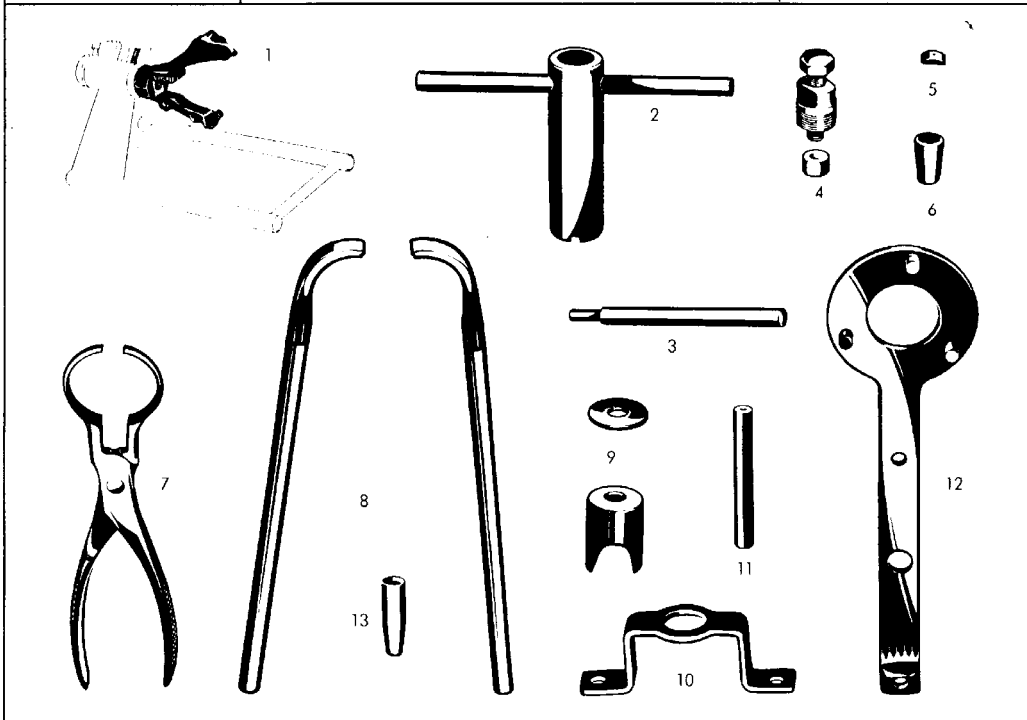

One Set of Special Tools for the QUICKLY comprises: -

Fig. No. 1	1 Clamping fixture for engine	16 91 00 901
	(If an NSU assembly stand is not available, it is possible to make do by holding the clamping fixture in a vice.)	
Fig. No. 2	1 Box spanner for pedal crank spindle nuts	16 91 00 902
Fig. No. 3	1 Punch for gudgeon pin	16 91 00 903
Fig. No. 4	1 Extractor with cap for flywheel with pole shoes	16 91 00 904
Fig. No. 5	1 Filler piece for pedal crank spindle	16 91 00 905
Fig. No. 6	1 Tapered sleeve for fitting left-hand end of pedal crank spindle	16 91 00 906
Fig. No. 7	1 Piston ring pliers	16 91 00 907
Fig. No. 8	2 Levers for removing clutch cup	16 91 00 908
Fig. No. 9	1 Assembly sleeve for inner clutch casing	16 91 00 909
Fig. No. 10	1 Assembly bracket for clutch spring	16 91 00 910
Fig. No. 11	1 Setting pin for connecting rod	16 91 00 911
Fig. No. 12	1 Holder for rotor and intermediate gear	16 91 00 913
Fig. No. 13	1 Tapered sleeve for use when assembling crankcase	01 81 10 282

These tools are supplied in sets, the number for which is **16 91 01 914**.

To remove the chain sprocket, a normal commercial extractor or Fox extractor No. 048 422 007 will also be required.

The right to make technical modifications or to alter the price is reserved.



SERVICE

FLATE RATE TIMES FOR REPAIR TASKS

QUICKLY

Flate Rate Repair Times / Page 1

Edition IX, 1956

The Flate Rate Repair Times have been calculated for vehicles with the standard equipment. The time required for any cleaning that may be necessary is **not** included.

Engine

- M 01 Remove engine from frame and replace
- M 02 Strip and assemble engine
- M 04 Remove and fit cylinder head
- M 10 Remove and fit cylinder and piston
- M 11 Decarbonise cylinder head, piston, and exhaust system
- M 15 Remove and fit clutch. Adjust and replace any parts necessary
- M 16 Remove and fit chainguard
- M 21 Remove and fit chain sprocket (engine)
- M 22 Remove and fit circlip on chain sprocket
- M 25 Remove and fit rear chain
- M 30 Remove and fit crankshaft and main bearings
- M 31 Remove and fit crankcase
- M 32 Change crankcase gasket
- M 35 Remove and fit gearbox and gearchange mechanism, replace parts as necessary
- M 36 Remove and fit gearbox shaft bearings and bushes
- M 50 Remove and fit magneto cover plate

Time for task (hours)	Additional work required	Total time (hours)
1 ¹ / ₂		1 ¹ / ₂
3 ³ / ₄	M 01	5 ¹ / ₄
1 ¹ / ₄		1 ¹ / ₄
1 ¹ / ₂	M 04	1 ¹ / ₂
1 ¹ / ₂	M 04	1 ¹ / ₂
1 ¹ / ₄	M 16	1 ¹ / ₄
1 ¹ / ₄		1 ¹ / ₄
1 ¹ / ₄	M 16	1 ¹ / ₄
1 ¹ / ₄	M 16, M 21	7 ¹ / ₄
1 ¹ / ₄		1 ¹ / ₄
1 ¹ / ₄	M 01, M 02	5 ¹ / ₄
1 ¹ / ₄	M 01, M 02	5 ¹ / ₄
3	M 01	4 ¹ / ₂
1 ¹ / ₄	M 01, M 02	5 ¹ / ₂
1 ¹ / ₄	M 01, M 02	5 ¹ / ₄
1 ¹ / ₄		1 ¹ / ₄

Ignition System and Dynamo

- Z 01 Adjust ignition timing
- Z 02 Remove and fit dynamo; adjust
- Z 03 Remove and fit contact-breaker points; adjust
- Z 04 Remove and fit condenser; check
- Z 05 Remove and fit ignition coil; check
- Z 06 Remove and fit ignition lead

1 ¹ / ₄	M 50	1 ¹ / ₂
1 ¹ / ₄	M 50	1 ¹ / ₂
1 ¹ / ₄	M 50, Z 02	7 ¹ / ₄
1 ¹ / ₄	M 50, Z 02	7 ¹ / ₄
1 ¹ / ₄	M 50, Z 02	7 ¹ / ₄
1 ¹ / ₄	M 50, Z 02	7 ¹ / ₄

Carburettor

- V 01 Remove and fit air filter; clean
- V 02 Remove and fit carburettor; clean, adjust, replace, parts as necessary

1 ¹ / ₄		1 ¹ / ₄
1 ¹ / ₄		1 ¹ / ₄

Wheels, Brakes, and Forks

- F 01 Remove and fit front wheel
- F 02 Remove and fit rear wheel
- F 03 Remove and fit ball-bearing cup or seal in hub
- F 04 Remove and fit front-brake back plate
- F 05 Remove and fit rear-brake back plate
- F 08 Renew brake linings (each brake)

1 ¹ / ₄		1 ¹ / ₄
1 ¹ / ₄		1 ¹ / ₄
1 ¹ / ₂	F 01 or F 02	1 ¹ / ₄
1 ¹ / ₄	F 01	1 ¹ / ₂
1 ¹ / ₄	F 02	1 ¹ / ₂
1 ¹ / ₄	F 01, F 04 or F 02, F 05	1 ¹ / ₄



NSU
SERVICE

FLATE RATE TIMES FOR REPAIR TASKS

QUICKLY

Flate Rate Repair Times Page 2

Edition IX, 1956

	Time for task (hours)	Additional work required	Total time (hours)
F 20 Remove and fit forks	1 1/4	F 01	1 1/4
F 21 Remove and fit steering-head cones and cups and ball bearings	1/4	F 20, F 01	1 1/4
F 24 Remove and fit pivoted links (left-hand and right-hand) ...	3/4	F 01	1
F 25 Replace bushes in pivoted links	3/4	F 01, F 24	1 1/4
F 26 Remove and fit front mudguard	1/4	F 01	1/2
Controls and Bowden Cables			
F 40 Remove and fit handlebars (with fittings)	3/4		3/4
F 41 Remove and fit handlebar bend	1/4		1/4
F 44 Remove and fit brake lever or clutch lever	1/4		1/4
F 45 Remove and fit throttle twistgrip	1/4		1/4
F 46 Remove and fit gear change twist grip	1/4		1/4
F 47 Remove and fit twistgrip sleeve	1/4		1/4
F 50 Remove and fit clutch cable	1/4	M 16	1/2
F 51 Remove and fit brake cable	1/4		1/4
F 52 Remove and fit decompression cable	1/4		1/4
F 53 Remove and fit throttle cable	1/4		1/4
F 54 Remove and fit gearchange cable	1/4	M 50	1/2
Frame			
F 60 Remove and fit frame	1/4	M 01, F 02, F 20 F 62, F 72, F 75, F 80	4 1/2
F 62 Remove and fit rear mudguard	1/2	F 02	1
F 70 Remove and fit exhaust system	1/4		1/4
F 72 Remove and fit pivoted saddle	1/4		1/4
F 74 Remove and fit centre stand	1/4		1/4
F 75 Remove and fit luggage carrier	1/4		1/4
F 80 Remove and fit fuel tank	1/4		1/4
F 82 Remove and fit fuel tap	1/4		1/4
F 85 Remove and fit pedals	1/4		1/4
Electrical Installation			
E 02 Remove and fit rear lamp lead	1		1
E 04 Remove and fit lighting leads	1		1
E 09 Remove and fit rear lamp	1/4		1/4
E 12 Remove and fit headlamp glass or reflector	1/4		1/4
E 13 Remove and fit headlamp	1/2		1/2
Care and Maintenance			
W 01 Grease vehicle	1/4		1/4



Supplement to Quickly Maintenance Manual (October 1956 Issue.)

(Repairs on **Quickly-S** and **L** which differ from the normal repair work on Quickly machines)

(The symbol „SW“ denotes across-flats, in mm)

WHEELS, BRAKES AND FORKS

Front Wheel - Removal and Fitting (S and L) (F 01)

1. Disconnect the front brake cable nipple from the bottom brake lever. Undo the left-hand spindle nut (SW 15), slacken off the two pinch bolts (SW 12) on the swinging links and drive the spindle out to the right. Withdraw the wheel.

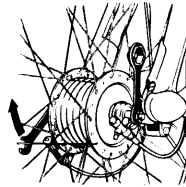

Fig. F 01/1

2. Assemble in the reverse order, seeing that the sealing ring seats properly in the left-hand side of the hub. On machines not equipped with a speedometer, the two spacer rings should be fitted to the left-hand spindle cone.

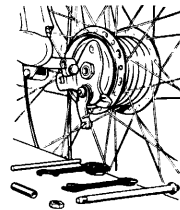

Fig. F 01/1 α

Rear Wheel - Removal and Fitting (L) (F 02)

1. Remove the safety loop, washer and pin from the rear brake lever. Undo the left-hand spindle nut (SW 15), drive the spindle out, and remove with the chain adjusters and distance piece. Lift the chain off the rear sprocket and withdraw the wheel downwards and to the left.

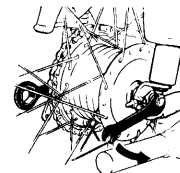

Fig. F 02/1

2. Assemble in the reverse order. Adjust the chain tension with the machine riderless so that it has about $\frac{3}{4}$ " (20 mm) free up-and-down movement; check to see that the wheels are properly aligned.

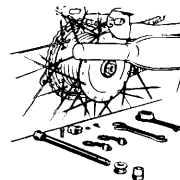

Fig. F 02/1 α

Bearing Cups and Seals - Removal and Fitting (S and L) (F 03)

1. Front wheel removal (see F 01). Front brake plate removal (s. F 04), or Rear wheel removal (see F 02). Rear brake plate removal (s. F 05).
2. Grip the left-hand cone in a vice by its two flats and completely unscrew the right-hand cone (SW 15). Force the cone, ball holder and seal right out two strong screwdrivers. Knock the left-hand cone out with a suitable drift, and use a strong screwdriver to remove the seal and ball holder. Knock the bearing cups out with a flat drift.
3. Assembly: Carefully tap the cups in with a suitable drift. Knock the right-hand cone in, complete with ball race and sealing ring, using grease to ease them in. Screw the left-hand cone on a few turns, together with its ball holder and seal (the lips on both seals should face inwards), and then knock the sealing ring into position. Set the bearings so that no play can be felt.

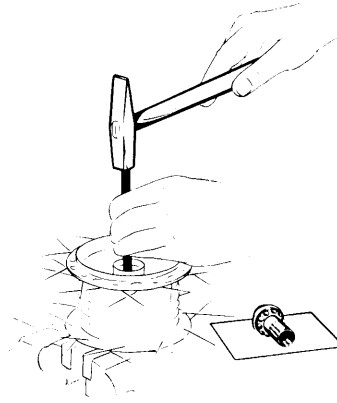

Fig. F 03 2b

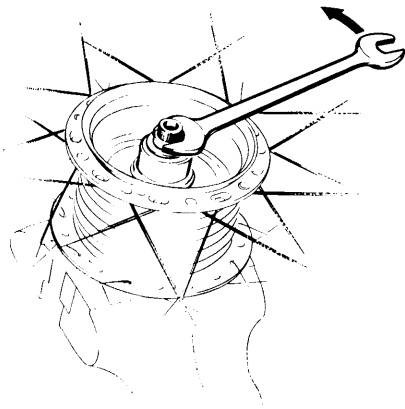

Fig. F 03 2

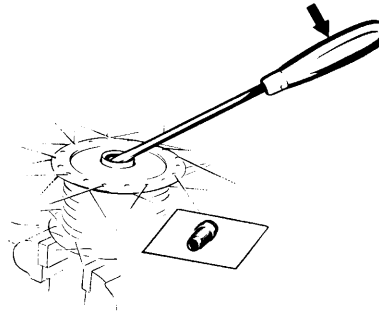

Fig. F 03 2c

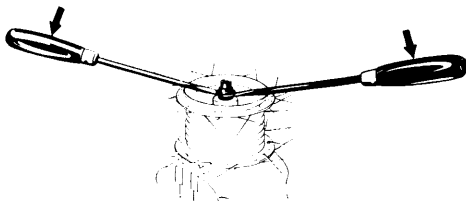

Fig. F 03 2a

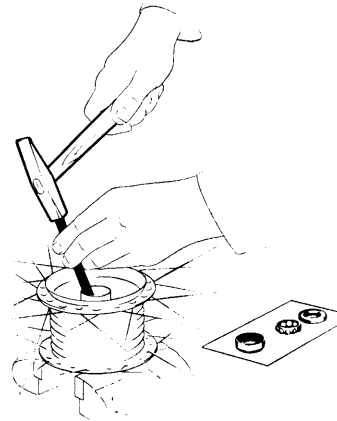

Fig. F 03 2d

Front Brake Plate - Removal and Fitting (S and L)

(F 04)

1. Front wheel removal (see F 01).
2. Undo the hexagon nut (SW 22) (applying apposite pressure to the brake lever) and take out the brake plate. Don't overlook the shim between the bearing cone and brake plate!
3. Assemble in the reverse order.

Rear Brake Plate - Removal and Fitting (S and L)

(F 05)

1. Rear wheel removal (see F 02).
2. The next stages are described in F 04. Tilt the brake plate and lift it out with its cover plate.
3. Assemble in the reverse order. First slip the cover plate over the sprocket.

Rear Sprocket - Removal and Fitting (S and L)

(F 06)

1. Rear wheel removal (see F 02).
2. Rear brake plate removal (see F 05).
3. Undo all the nuts (SW 9) with spring washers, and remove the sprocket and retaining screws.
4. Assemble in the reverse order and lock the nuts with a centre punch.

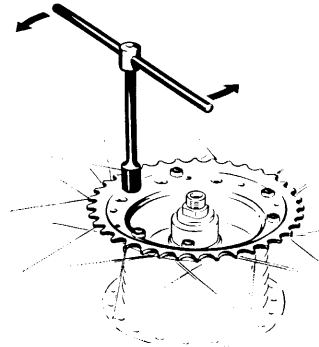

Fig. F 06 3

Rear Hub Cover - Removal and Fitting (S and L)

(F 07)

1. Rear wheel removal (see F 02).
Rear brake plate removal (see F 05).
3. Assemble in the reverse order, taking care to see that the brake lever is fitted in the correct position. Don't forget the shim between the bearing cone and brake plate.

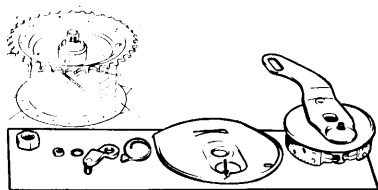

Fig. F 07 2

2. Undo the nut (SW 11), remove the spring washer. Mark the position of the brake lever, force the lever off and withdraw the cover.

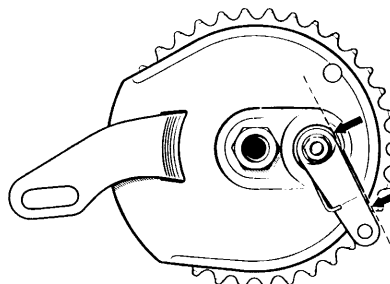

Fig. F 07 2 a

Brake Linings on each Hub - Renewal (S and L)

(F 08)

1. Front wheel removal (see F 01).
Front brake plate removal (see F 04), or rear wheel removal (see F 02).
Rear brake plate removal (see F 05).
2. Unhook the return spring with a screwdriver and remove the brake shoes. Shear the rivet heads off with a chisel on the rear face of the brake shoes. Punch the remaining rivet portions out and take the linings off. When fitting the new linings, start riveting from the centre outwards.
3. Assembly: Fit both shoes into position and make sure when refitting the springs that they engage with the grooves in their anchor pins. Replace the brake plate into the hub, complete with shoes, turn the wheel and apply the brake. Remove the brake plate and smooth out any high spots on the linings with a file.

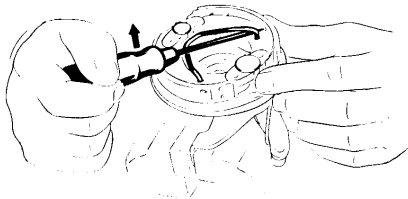

Fig. F 08/2

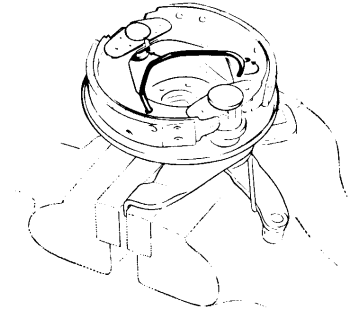

Fig. F 08 3

Front Forks - Removal and Fitting (L)

(F 20)

1. Front wheel removal (see F 01).
Front mudguard removal (see F 26).
Headlamp unit removal (see E 13).
Speedometer removal (see F 42).
Bell removal or rattle removal (see F 84 or E 08).
2. Undo the ring nut (SW 32) with a conventional twelve-sided socket spanner or with special spanner 16 91 00 917. Remove the two screws (SW 14) and serrated washers on the front forks, and place the complete handlebars on to the fuel tank (protect the tank with a soft rag). Remove the washer and undo the locknut (SW 36) (the

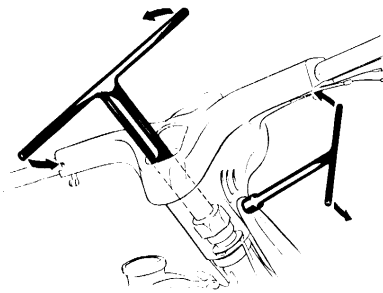

Fig. F 20 2

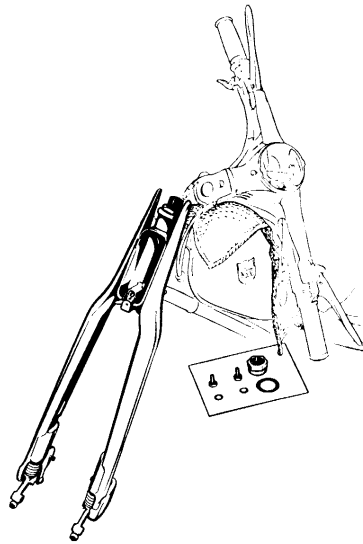

Fig. F 20 2 a

balls will drop out of the bearings; the top and bottom races each contain 21 balls). Finally, remove the forks, cover plate, and the top bearing cone.

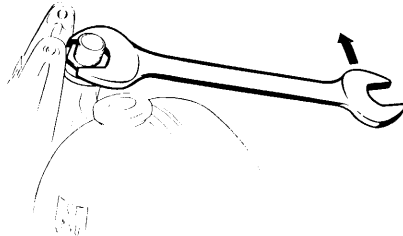

Fig. F 20 2 b

3. Assemble in the reverse order. Adjust the fork by means of the locknut in such a way that it is free to swing over to either side under its own weight without the slightest sign of play. Lock by means of the nut (SW 32) and the ring nut. (The ring nut must be brought to bear up against the nut before it is screwed into the forks.)



correct

wrong

Fig. F 20/3

Bearing Cones and Cups, Balls - Removal and Fitting (S and L)

(F 21)

1. Front wheel removal (see F 01).
Front fork removal (see F 20).
2. Remove the cover plate, the top steering cone and balls, also the balls in the lower cone and cup. Drive the top and bottom steering head cups out with a suitable drift. Tap the steering cone off the fork tube with a flat drift, or lever it off with two screwdrivers.
3. Assembly: After driving the lower steering cone into the fork tube by means of a suitable piece of tubing and driving the two cups into the frame, insert 21 balls [$\frac{13}{16}$ " dia (5 mm)] into the cups, using plenty of grease. For further assembly see F 20.



Fig. F 21 2

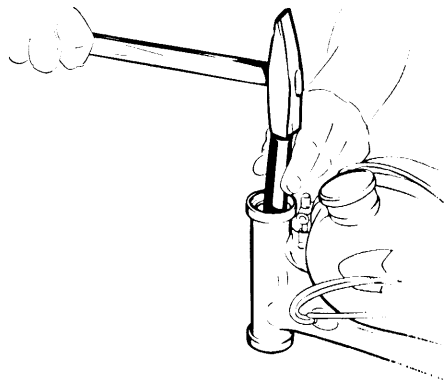

Fig. F 21 2 b

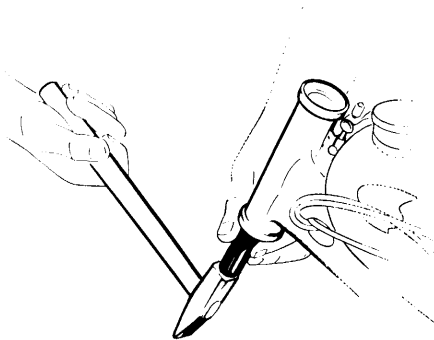

Fig. F 21 2 a

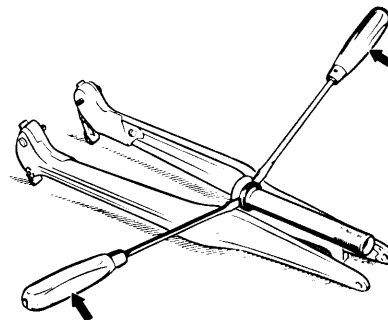

Fig. F 21 2 c

Swinging Links, Right and Left-hand - Removal and Fitting (S and L) (F 24)

1. Front wheel removal (see F 01).
2. Bend the front and rear tabs on the covering caps over to the left and right respectively. Remove the nut (SW 10) and its washer, (push the swinging link upwards and withdraw the hexagon screw), and remove the stop. Undo the locknuts (SW 14) on both bearing screws. Remove the screws and lift off the swinging links, complete with cover plates, distance bushes, fork springs and rubber plugs.
3. Assemble in the reverse order. Carefully bend over the tabs on the covering caps. Springs must always be replaced in pairs, observing the colour coding at their ends (yellow, blue, etc.).

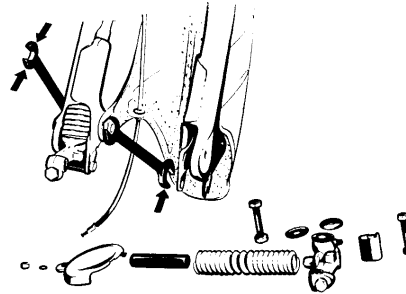

Fig. F 24

Bushes, Swinging Links - Renewal (S and L) (F 25)

1. Front wheel removal (see F 01).
Swinging links removal (see F 24).
2. Drive the old bushes out with a suitable drift and press the new bushes in. Ream the bores out until the bushes are a sliding fit.

Front Mudguard - Removal and Fitting (L) (F 26)

1. Front wheel removal (see F 01).
Remove the protecting caps and the locknuts (SW 14) (see F 24).
2. Undo the screw (SW 10) in the centre of the mudguard (inside) and remove with its spring washer; then remove the mudguard.
3. Assemble in the reverse order.

CONTROL LEVERS and CONTROL CABLES

Handlebars (including fittings) - Removal and Fitting (L) (F 40)

1. Headlamp unit removal (see E 13). Bell removal or rattle removal (see F 84 and E 08 respectively). Speedometer removal (see F 42). Disconnect the clutch, front brake decompressor, carburetter and gear change control cables (see F 50, F 51, F 52, F 53, F 54).
2. Unscrew the nut (SW 32) with a conventional twelve-sided socket spanner or with special spanner 16 91 00 917, remove the 2 screws (SW 14) at the top fork ends their lock washer and lift the handlebars off.
3. Assemble in the reverse order.

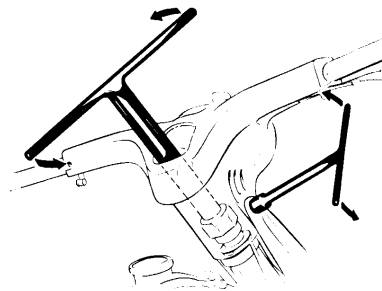

Fig. F 40 2

Handlebar Bend - Removal and Fitting (F 41)

1. (see F 40).
Front brake control lever removal (F 44).
Twistgrip, throttle removal (F 45).
Twistgrip, gear change control removal (F 46).
2. Assemble in the reverse order.

Speedometer - Removal and Fitting (F 42)

1. Headlamp unit removal (see E 13). Remove the toolbox lid. Disconnect the tension spring by removing the retaining clip from the underside of the headlamp shell. Undo the speedometer drive union nut and withdraw the speedometer upwards, complete with tension spring and flexible drive.
2. Assemble in the reverse order. A bent spoke can be used to reconnect the spring.

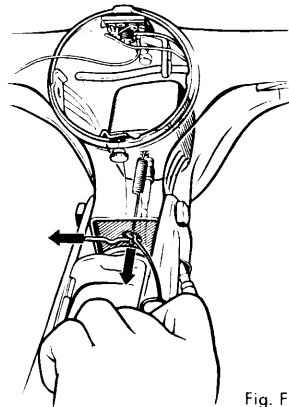

Fig. F 42

Flexible Drive, Speedometer - Removal and Fitting (F 43)

(see F 42).

Control Lever, Front Brake - Removal and Fitting (F 44)

1. Disconnect the front brake control cable (see F 51). Undo the lever retaining screw (SW 9) on the underside of the handlebar and remove, with its washer, plate spring and the lever itself.
2. Assemble in the reverse order. The plate spring must be fitted with its convex side facing the head of the screw.

Control Lever, Clutch - Removal and Fitting (F 44 a)

1. Disconnect the clutch control cable (see F 50). Remove the nut (SW 9) and its serrated washer, unscrew the retaining screw and take the lever off.
2. Assemble in the reverse order.

Twistgrip, Throttle - Removal and Fitting (L)

(F 45)

1. Close the twistgrip. Undo the locknut (SW 9) on the underside of the twistgrip housing, unscrew the grub screw a few turns, turn the twistgrip and thrust washer to the right and withdraw.
2. Assemble in the reverse order. Grease the slider and screw the grub screw in until the twistgrip no longer closes by itself; then lock with the locknut (SW 9).

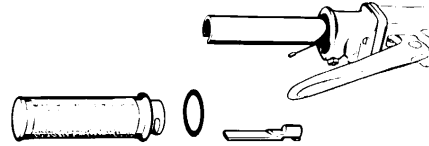

Fig. F 45

Twistgrip, Gear Change Control - Removal and Fitting (L)

(F 46)

1. Headlamp unit — removal (see E 13).
Speedometer — removal (see F 42).
Control cable, clutch, removal (see F 50).
Control cable, gear change removal (see F 54).
2. Remove the slotted screw from the decompressor control lever with its serrated, corrugated and plain washers; unscrew the slotted screw and grub screw after undoing a locknut (SW 9). Pull the twistgrip slightly outwards, turning it upwards at the same time, and disconnect the gear change control cable nipple in the headlamp recess. Remove the twistgrip, complete with its rod, housing and moulding strip.

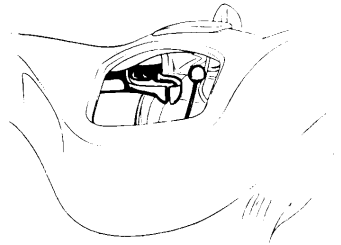

Fig. F 46 2 a

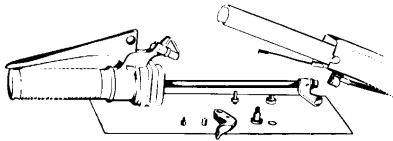

Fig. F 46 2

3. Assemble in the reverse order. Grease the twistgrip housing. Don't overlock the gear change rod bush! Adjust the gear change control system by means of the cable adjuster if required.

Rubber Grip, Twistgrip - Removal and Fitting (S and L)

(F 47)

1. Slightly lift the end of the grip with a small screwdriver and pour in a few drops of petrol. Withdraw the grip with a twisting motion.
2. Assembly: — Wet the grips with petrol and push them on with a quick twisting motion.

Slider - Removal and Fitting (L)

(F 48)

1. (see F 53), excluding „Control Cable — Removal and Fitting“.

Control Cable, Clutch - Removal and Fitting (L)

(F 50)

1. Headlamp Unit — Removal (E 13).
2. Remove the chainguard on the left-hand side of the engine, after first undoing its slotted screw and another screw on the right-hand side (above the lifting handle). Disconnect the nipple from the clutch lever (engine end). Remove the nipple holder from the clutch lever (handlebar lever), disconnecting the cable in the process.
3. Assembly: — Use the old Bowden cable to pull the new one through, tying the two together with binding wire.

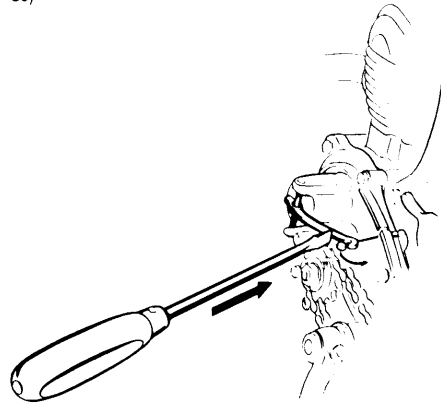

Fig. F 50

Control Cable, Front Brake - Removal and Fitting (L)

(F 51)

1. Disconnect the nipple from the lower brake lever. Remove the nipple holder from the handlebar-mounted lever. Set the adjuster and star nut with their slots in line, then disconnect the control cable and pull out upwards.
2. Assemble in the reverse order.

Control Cable, Decompressor - Removal and Fitting (L)

(F 52)

1. Headlamp Unit — Removal (see E 13).
2. Push the decompression lever on the cylinder head inwards with a screwdriver, and disconnect the cable. Undo the screw on the nipple, pull out the inner cable, and withdraw the Bowden cable downwards.
3. Assemble in the reverse order. Set the cable by means of the adjuster to leave about $\frac{3}{4}$ " (1 mm) free movement.

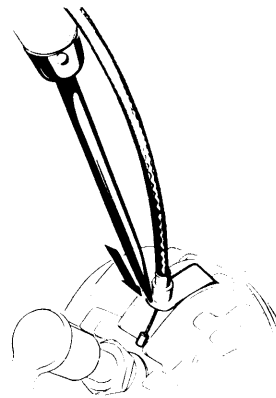

Fig. F 52

Control Cable, Throttle - Removal and Fitting (L) (F 53)

1. Twistgrip, Throttle — Removal (F 45).
Remove the carburettor screw cap and disengage the control cable nipple from the throttle slide. Slightly loosen the fuel tank mountings and slip the cable out underneath the rubber tank pads.
2. Assemble in the reverse order.

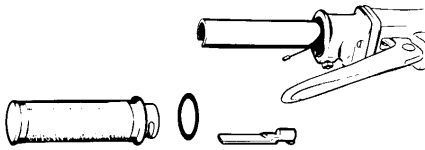

Fig. F 53

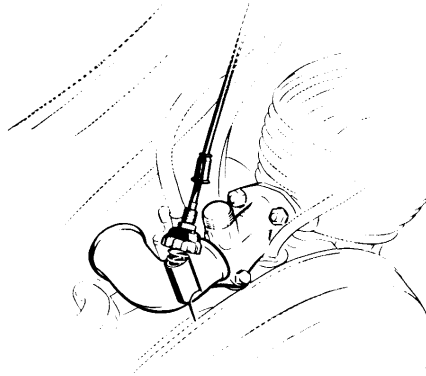

Fig. F 53 a

Control Cable, Gear Change - Removal and Fitting (L) (F 54)

1. Remove the flywheel magneto cover on the right-hand side after undoing the countersunk screw. Select 2nd gear, push the gear selector lever inwards and disconnect the nipple. Next, carry out the operations listed in F 46, up to „disconnect the gear change control cable nipple in the headlamp recess“. Tie about 5 feet (1 m 50) of binding wire to the bottom nipple and pull the cable out upwards.
2. Assembly: — Use the same length of wire to pull the new cable through. Fit the slotted cable bush into the right-hand crankcase half; connect the top nipple first. Try all the gears in turn and adjust the control system by means of the adjuster.

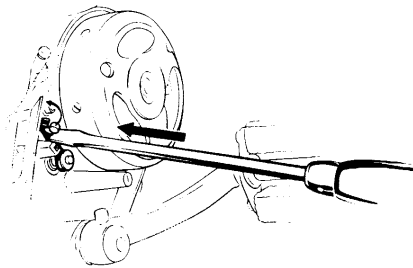

Fig. F 54

Control Cable, Rear Brake - Removal and Fitting (L) (F 56)

1. Remove the front and rear locking springs. Remove the washers and pins. Undo the locknut (SW 10) and unscrew the adjuster (SW 9). Remove the cable clip and pull out the cable and rubber sleeves.
2. Assemble in the reverse order. Make sure the cable is correctly adjusted.

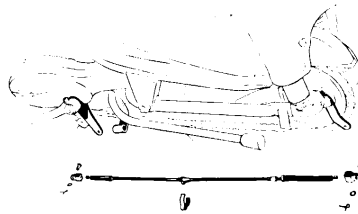

Fig. F 56

FRAME

Frame - Removal and Fitting (L)

(F 60)

1. Front Forks — Removal (see F 20).
Control cables removal (see F 50, F 51, F 52, F 54).
Fuel tank — removal (see F 80).
Frame, rear frame member removal (see F 62).
Rear wheel removal (see F 02).
Removing the power unit (see M 01).
Rear suspension swinging arm removal (see F 63).
2. Assemble in the reverse order. Fit all the Bowden cables and the electric wiring harness to the frame before fitting the engine.

Frame, Rear Frame Member - Removal and Fitting (L)

(F 62)

1. Rear wheel removal (see F 02).
Pivoted saddle removal (see F 72).
Rear light removal (see E 09).
2. Pull the rear light lead out through the eyes.
Remove the blanking plug on the upper left-hand side and undo the slotted screw. Remove the two front slotted screws and their washers, spring washers and nuts (SW 10). Unscrew the two screws (SW 10) at the rear and remove, with their washer, spring washers and nuts. Lift the complete rear frame member off, with its moulding strip, clips, spacers and seals.

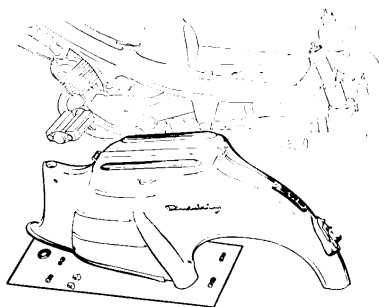

Fig. F 62 2

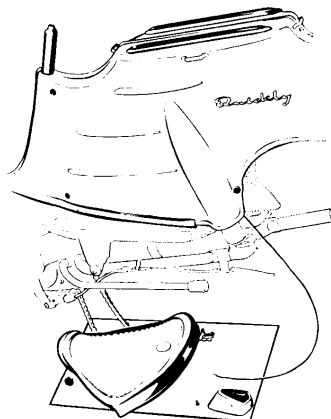

Fig. F 62

3. Assemble in the reverse order. Insert the seal above the retaining clip into the rear frame member before placing the latter on to the frame. Finally, tighten the top slotted screw.

Rear Suspension Swinging Arm - Removal and Fitting (L) (F 63)

1. Rear wheel — removal (F 02).
Frame, rear frame member removal (F 62).
2. Unscrew the locknuts (SW 9), holding the threaded disc in place (SW 18). Twist the retaining rods out with a screwdriver, then push the swinging arm down and remove the springs, spring caps, and shock absorbers. Push the lock washers out and remove the distance bushes, spring washers sliders and retaining rods. Undo the Bowden cable adjuster (SW 9) and locknut (SW 10). Unscrew the self-locking nuts (SW 14) on the inside of the swinging arm and drive the bearing bolts out from the inside with a brass drift. Remove the swinging arm with its inner and outer shims.

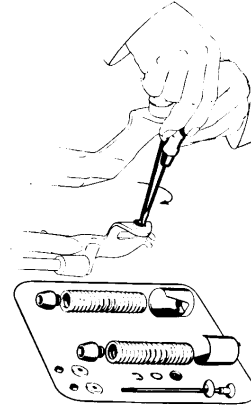

Fig. F 63 2 b

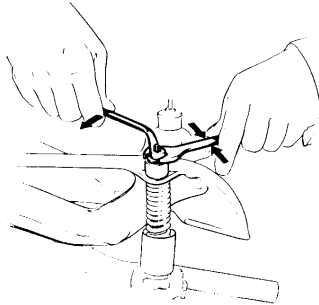

Fig. F 63 2

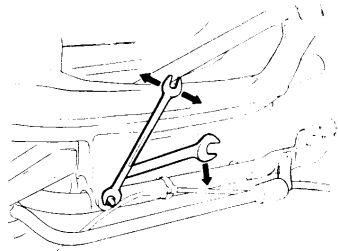

Fig. F 63 2 c

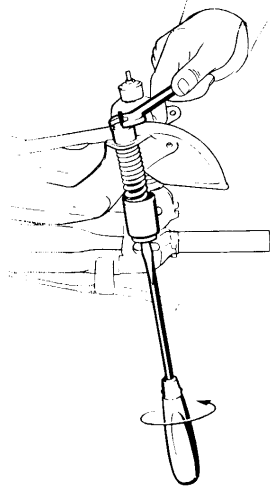

Fig. F 63.2 a

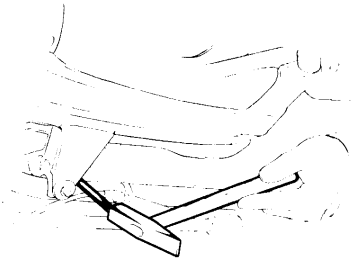

Fig. F 63 2 d

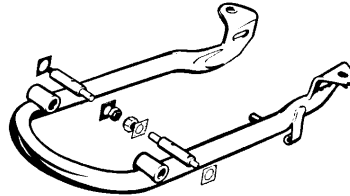

Fig. F 63.2 e



3. Assembly: — Stick the outer and inner shims to the bearing brackets with grease, grease the bearing bushes, place the swinging arm into position, insert the bearing bolt, seeing that the shims are correctly positioned, and drive the bearing bolt in with drift 11 91 00 921 or with a suitable piece of tubing. Then draw up the self-locking nuts (SW 14) dead tight. Coat the slider with graphite and then insert it, together with the retaining rod, from the bottom; slip the distance bush and spring washer over the end of the swinging arm and lock. Fit the spring caps with the end holes facing forward. Insert the springs, push the shock absorbers into position, lift the swinging arm and screw the threaded discs in until there is a clearance of $4 \frac{1}{4}$ " (106 mm) between the swinging arm and the frame on both sides. Lock the threaded discs with the locknuts (SW 9). Carry out the remaining assembly in the reverse order to dismantling.

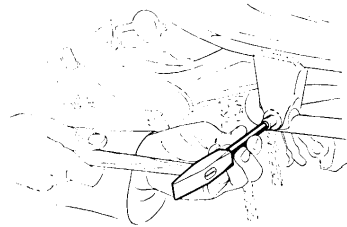

Fig. F 63 3

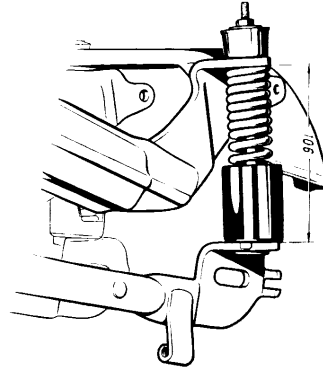

Fig. F 63 3 a

Rear Suspension - Removal and Fitting (L)

(F 65)

1. Rear wheel removal (F 02).
Frame, rear frame member — removal (F 62).
Remaining operations, see F 63, para. 2, not including swinging arm removal.
2. Assemble in the reverse order. Fork springs should only be renewed in pairs, noting the colour coding (yellow, blue, etc.).

Exhaust System - Removal and Fitting (L)

(F 70)

1. Remove the screw (SW 10) and its spring washer from the clip on the frame. Undo the exhaust pipe nut on the cylinder and then remove the exhaust system with its gasket.
2. Assemble in the reverse order. Lubricate the exhaust pipe nut with graphite when refitting.

Pivoted Saddle - Removal and Fitting (L)

(F 72)

1. Undo the nut (SW 15) on the saddle clamp and remove the saddle.
2. Assemble in the reverse order.

Pedals - Removal and Fitting

(F 85)

1. The left and right-hand pedals are marked „L“ (left-hand thread) and „R“ (right-hand thread) respectively. Unscrew the pedals with an open-ended spanner (SW 15).
2. Assemble in the reverse order.

ELECTRICAL SYSTEM

Cable - Rear Light - Removal and Fitting (S and L)

(E 02)

1. Headlamp unit removal (E 13). Disconnect both leads from their terminals and withdraw downwards, with their protecting sleeve. Remove the countersunk screw from the rear light, remove the protecting cap and disconnect the lead. Withdraw the cables to the front through the eyes in the rear frame member. Tie about 5 feet (1,5 m) of binding wire to the end of the cable and pull it out to the front.
2. Assembly: — Pull a new cable through, using binding wire as before. Connect the rear light lead to the red terminal in the headlamp (see Wiring Diagram).

Wiring Diagram
(Quickly N and S)

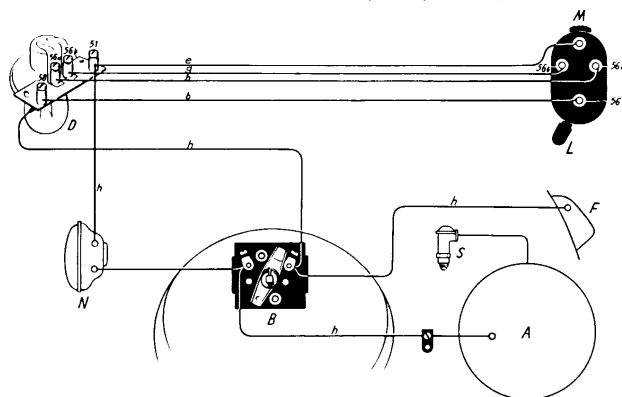

- A Flywheel magneto and lighting generator
- B Switch plate
- D Double filament bulb
- F Rear lamp
- L Dipper switch
- N Horn
- S Sparking plug
- b red
- e white
- g green
- h grey

Wiring Diagram
(Quickly L)

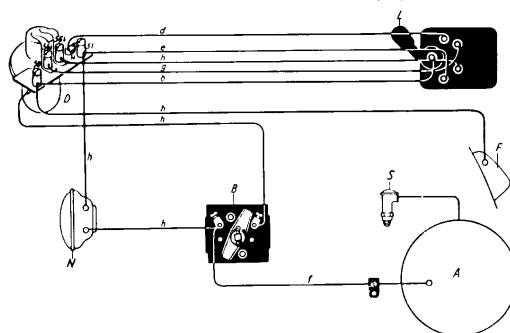

- A Flywheel dynamo
- B Starting, ignition and lighting switch
- D Headlamp bulb (double filament)
- F Tail light bulb
- L Dipper switch
- N Horn
- S Sparking plug
- b red
- d yellow
- e white
- f blue
- g green
- h grey

Cables, Main Lighting - Removal and Fitting (S and L)

(E 04)

1. Headlamp unit removal (E 13).
Disconnect both leads from their terminals and withdraw downwards, with their protecting sleeve. Remove the flywheel magneto cover on the right-hand side, after undoing the slotted screw, and disconnect the lead. Withdraw the cable as described in E 02.
2. Assembly: — See E 02 (Refer to the Wiring Diagram).

Cables, Dipped Beam - Removal and Fitting (L Export)

(E 05)

1. Dipswitch removal (see E 10).
Headlamp unit removal (see E 13).
Disconnect all the dipper cables and withdraw.
2. Assemble in the reverse order, connecting up as shown on the Wiring Diagram.

Rattle - Removal and Fitting (L Export)

(E 08)

1. Headlamp unit removal (see E 13).
Undo the screw (SW 10) and remove, with its spring washers. Disconnect the lead and remove the rattle.
2. Assemble in the reverse order.

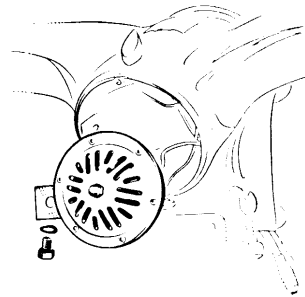

Fig. E 08

Rear Light - Removal and Fitting (L)

(E 09)

1. Remove the countersunk screw and the protecting cap. Disconnect the lead. Remove the nuts (SW 9) on the inside of the rear frame member, together with their lock washers, and remove the bulb-holder unit and rubber backing plate.
2. Assemble in the reverse order.

Dipswitch - Removal and Fitting (L Export) (E 10)

1. Remove the countersunk screw from the dip-switch, push the distance ring out with a small screwdriver and take the switch, terminal plate and horn button out of the housing. Disconnect the leads, taking care to mark them.
2. Assemble in the reverse order, (Refer to the wiring diagram).

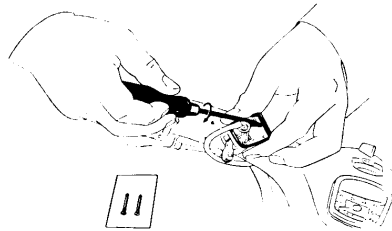

Fig. E 10 1

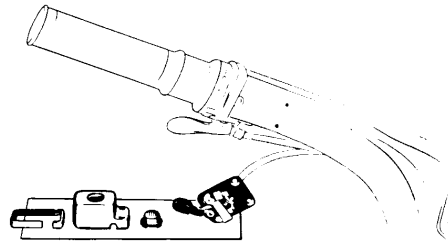

Fig. E 10 1 a

Headlamp Glass and Reflector - Removal and Fitting (L) (E 12)

1. Headlamp unit — removal (see E 13).
2. Push the terminal over to one side and remove the bulb. Undo the adjusting screw with a screwdriver and remove the compression spring, washer, earth terminal and square nut. Remove both retaining springs and lift the reflector out. Remove the three retaining springs from the headlamp glass and take the sealing ring off.
3. Assemble in the reverse order. Fit the headlamp glass with its projecting part facing downwards and engaging in the slot provided in the headlamp rim. When the headlamp unit has been fitted, set the reflector by means of the adjusting screw.

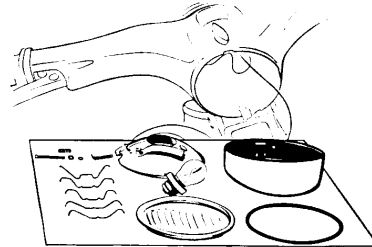
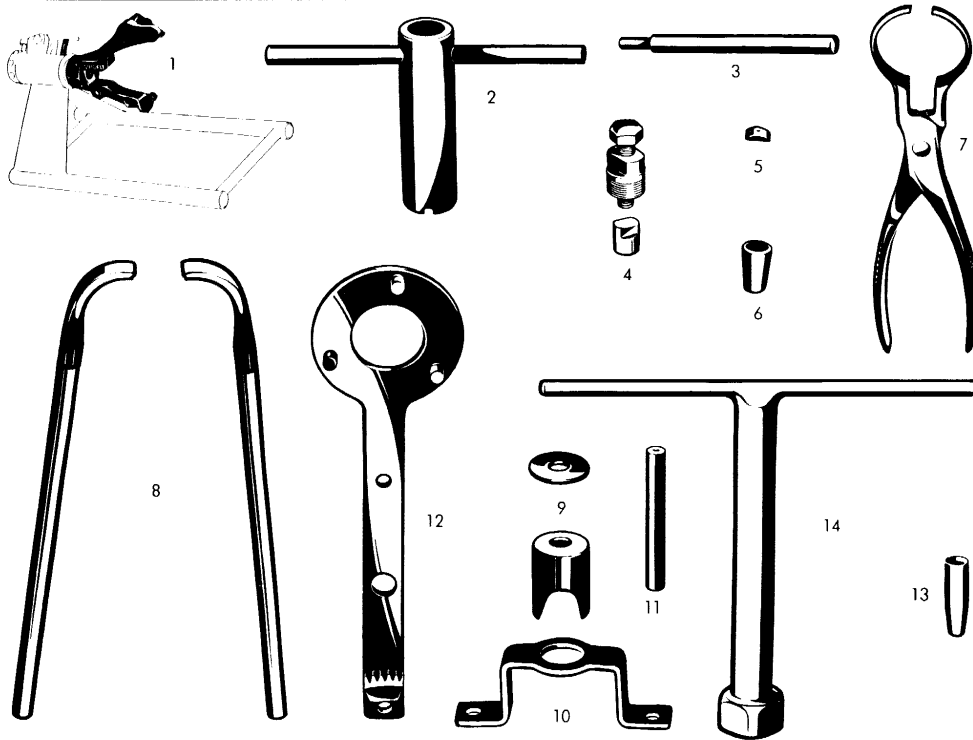

Fig. E 12

Headlamp Unit - Removal and Fitting (L) (E 13)

1. Undo the knurled screw on the underside of the headlamp unit, remove the unit and disconnect the leads.
2. Assemble in the reverse order.



One Set of Special Tools for the QUICKLY comprises: -

Fig. No.		
1	1 Clamping fixture for engine	16 91 00 901
	(If an NSU assembly stand is not available, it is possible to make do by holding the clamping fixture in a vice.)	
2	1 Box spanner for pedal crank spindle nuts	16 91 00 902
3	1 Punch for gudgeon pin	16 91 00 903
4	1 Extractor with cap for flywheel with pole shoes	16 91 02 904
5	1 Filler piece for pedal crank spindle	16 91 00 905
6	1 Tapered sleeve for fitting left-hand end of pedal crank spindle	16 91 00 906
7	1 Piston ring pliers	16 91 00 907
8	2 Levers for removing clutch cup	16 91 00 908
9	1 Assembly sleeve for inner clutch casing	16 91 00 909
10	1 Assembly bracket for clutch spring	16 91 00 910
11	1 Setting pin for connecting rod	16 91 00 911
12	1 Holder for rotor and intermediate gear	16 91 00 913
13	1 Tapered sleeve for use when assembling crankcase	018 110 282

These tools are supplied in sets, the number for which is **16 91 01 914**.

To remove the chain sprocket, a normal commercial extractor or Fox extractor No. 048 422 007 will also be required.

Special tool required additionally for model »L«

Fig. No. 14 1 Box spanner for disassembling of handlebar 16 91 00 917.



SERVICE

FLAT RATE TIMES FOR REPAIR TASKS

QUICKLY
Chassis
Flat Rate Repair Times / Page 51
Edition XII, 1957

The Flat Rate Repair Times have been calculated for vehicles with the standard equipment. The time required for any cleaning that may be necessary is **not** included.

Wheels, Brakes, and Forks

F 01	Remove and fit front wheel (S and L)
F 02	Remove and fit rear wheel (L)
F 03	Remove and fit ball-bearing cup or seal in hub (S and L)
F 04	Remove and fit front-brake back plate (S and L)
F 05	Remove and fit rear-brake back plate (S and L)
F 06	Remove and fit rear sprocket (S and L)
F 07	Remove and fit rear hub cover (S and L)
F 08	Renew brake linings (each brake) (S and L)
F 20	Remove and fit forks (L)
F 21	Remove and fit steering-head cones and cups and ball bearings (S and L)
F 24	Remove and fit pivoted links (left-hand and right-hand) (S and L)
F 25	Replace bushes in pivoted links
F 26	Remove and fit front mudguard

Control and Bowden Cables

F 40	Remove and fit handlebars (with fittings) (L)
F 41	Remove and fit handlebar bend (L)
F 42	Remove and fit speedometer (L)
F 43	Remove and fit flexible drive, speedometer (L)
F 44	Remove and fit control lever, front brake (L)
F 44a	Remove and fit control lever, clutch (L)
F 45	Remove and fit throttle twistgrip (L)
F 46	Remove and fit gear change twist grip (L)
F 47	Remove and fit twistgrip sleeve (S and L)
F 48	Remove and fit slider (L)
F 50	Remove and fit clutch cable (L)
F 51	Remove and fit brake cable (L)
F 52	Remove and fit decompression cable (L)
F 53	Remove and fit throttle cable (L)
F 54	Remove and fit gearchange cable (L)
F 56	Remove and fit control cable, rear brake (L)

Time for task (hours)	Additional work required	Total time (hours)
¼	—	¼
¼	—	¼
½	F 01, F 04 or F 02, F 05	1
¼	F 01	½
¼	F 02	½
¼	F 02, F 05	¾
¼	F 02, F 05	¾
¾	F 01, F 04 or F 02, F 05	1 ¼
½	F 26, F 42, F 84 or F 08, E 13	1 ¾
¼	F 20	2
¾	F 01	1
¾	F 01, F 24	1 ¾
¼	F 01	½
¼	F 42, F 84, or E 08, E 13, F 50 F 51, F 52, F 53 F 54	1 ½
—	F 40, F 44, F 44a F 45, F 46	2 ½
¼	E 13	½
—	F 42	½
¼	—	¼
¼	—	¼
¼	—	¼
¼	F 42, s. F 50 and F 54	1
¼	—	¼
¼	s. F 53	¾
½	E 13	¾
¼	—	¼
¼	E 13	½
¼	F 45	½
½	s. F 46	1
¼	—	¼



Frame

F 60	Remove and fit frame (L)
F 62	Remove and fit rear frame member (L)
F 63	Remove and fit rear suspension swinging arm (L)
F 65	Remove and fit rear suspension (L)
F 70	Remove and fit exhaust system (L)
F 72	Remove and fit pivoted saddle (L)
F 73	Remove and fit prop stand (L)
F 74	Remove and fit centre stand (S and L)
F 75	Remove and fit parcel-carrier strips (L)
F 80	Remove and fit fuel tank (L)
F 82	Remove and fit fuel tap
F 84	Remove and fit bell (L)
F 85	Remove and fit pedals

Electrical Installation

E 02	Remove and fit rear lamp lead (S and L)
E 04	Remove and fit lighting leads (S and L)
E 05	Remove and fit cables, dipped beam (L Export)
E 08	Remove and fit rattle (L Export)
E 09	Remove and fit rear lamp (L)
E 10	Remove and fit dipswitch (L Export)
E 12	Remove and fit headlamp glass and reflector (L)
E 13	Remove and fit headlamp unit (L)

Care and Maintenance

W 01	Grease vehicle (L)
------	------------------------------

Time for task (hours)	Additional work required	Total time (hours)
¼	F 20, F 63, F 73 F 80, M 01	5¾
½	F 02, F 72, E 09	1¼
¾	F 62	2
¼	F 62, F 63	1¾
¼	—	¼
¼	—	¼
¼	—	¼
¼	—	¼
¼	F 02	½
¼	—	¼
¼	—	¼
¼	E 13	½
¼	—	¼
¾	E 13	1
¾	E 13	1
—	E 10, E 13	½
¼	E 13	½
¼	—	¼
¼	—	¼
¼	E 13	½
¼	—	¼
½	—	½



3 speed engines

When installing lay shaft make sure the side play is not more than .008-.011". Shims should only be installed at the large gear.

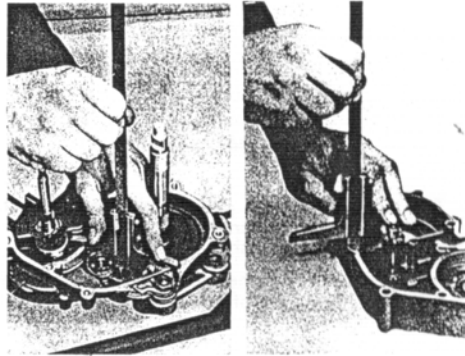

Mount left side crankcase half with gasket (use gasket cement if sealing surface is not perfect). To avoid tensions in the crankcase the center bolt has to be tightened last.

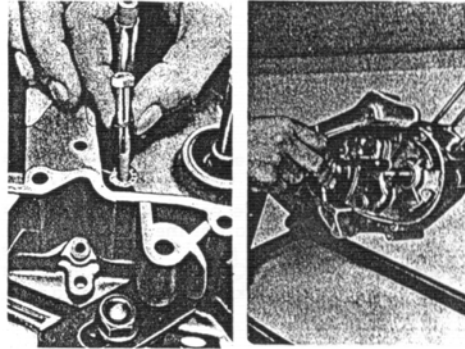

The easiest way to take the shifter cable off is to remove first the carburetor, and shift into 3rd gear. The next step is to screw both cable adjusters as close as possible together. Both cables can now be detached from the engine.

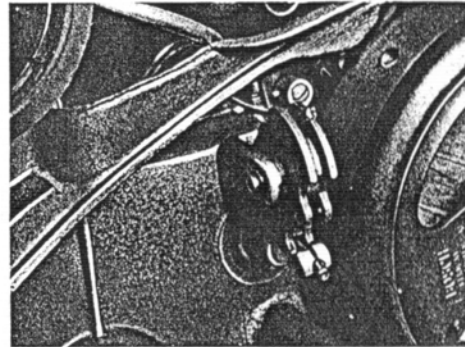

After loosening the screw on the shifter handle the twist grip sleeve can be pulled out and the cable be taken off.

Install the cable in reverse to the above description.

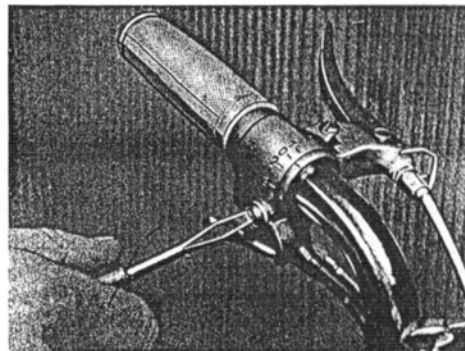

3 speed engines

The side play of the gear on the pedal shaft is .008-.011". It can be corrected by pressing in the spacer bush.

At Quickly T & TT the brake mechanism is on the right hand side of the engine.

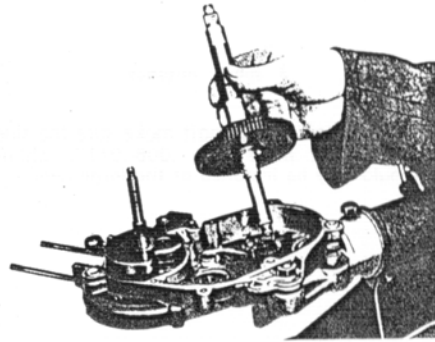

At Quickly N & S the brake mechanism is on the left hand side of the engine.

Note: To avoid side pressure to the spacer bush on the pedal shaft of the Quickly T & TT the left hand side pedal crank has to be mounted first. At Quickly N & S the right hand side pedal crank has to be mounted first.

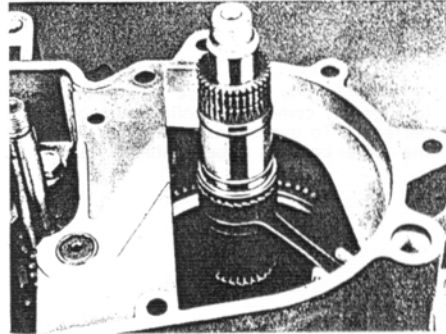

The claws of the mainshaft sliding gear which are machined on the inside diameter have to point to the 1st gear.

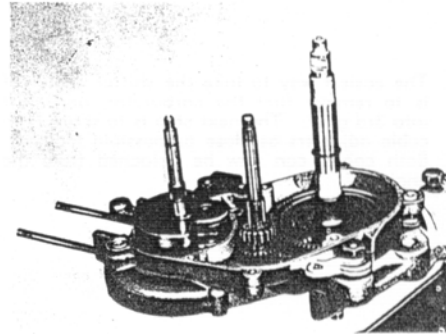

When mounting the piston make sure that the higher section of the piston windows face to the rear of the engine.

Take also care that the square hole in the cylinder head gasket covers with the hole in the cylinder.

Do not forget when setting the ignition timing that the magneto turns counter clock wise.

The oil filler plug is located behind the pedal shaft on the right hand engine side.

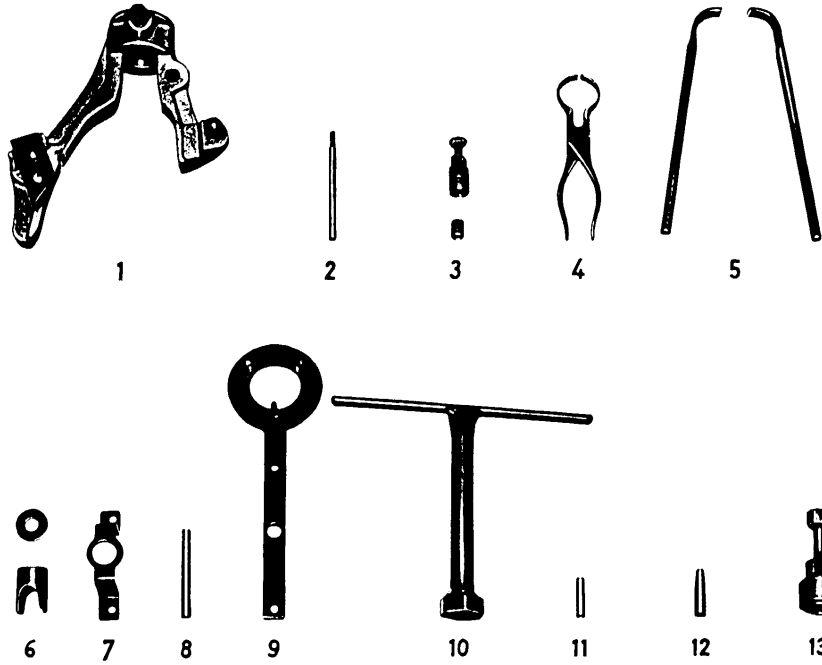

Quickly Special Tools

Illustr. #	Description	Parts #
1	mounting bracket	16 91 01 901
2	wrist pin drift	16 91 00 903
3	magneto flywheel puller	16 91 02 904
4	piston ring pliers	16 91 00 907
5	levers for clutch removal	16 00 00 908
6	fitting tool for inner clutch cup	16 91 00 909
7	bracket for clutch spring	16 91 00 910
8	checking mandrel for con. rod	16 91 00 911
9	holder for rotor and intermediate gear	16 91 01 913
10	box wrench for fork head nut	16 91 00 917
11	mounting sleeve for 3 speed striker shaft	16 91 00 919
12	mounting sleeve	110 282
13	sprocket puller	422 007
—	special tool set, compl.	16 91 02 914

Wiring diagram Quickly N - S

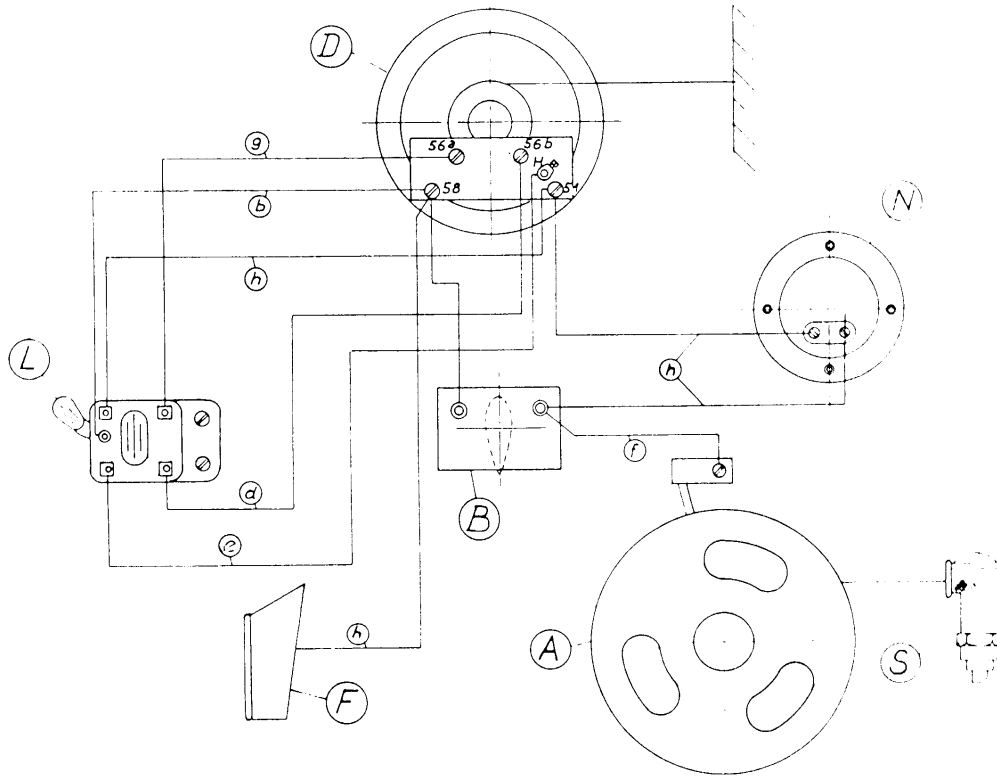

b red
 d yellow
 e white
 f blue
 g green
 h grey

A Magneto
 B HL switch
 D Head lamp
 F Tail lamp
 L Dimmer switch
 N Horn
 S Spark plug

Wiring diagram Quickly T - TT

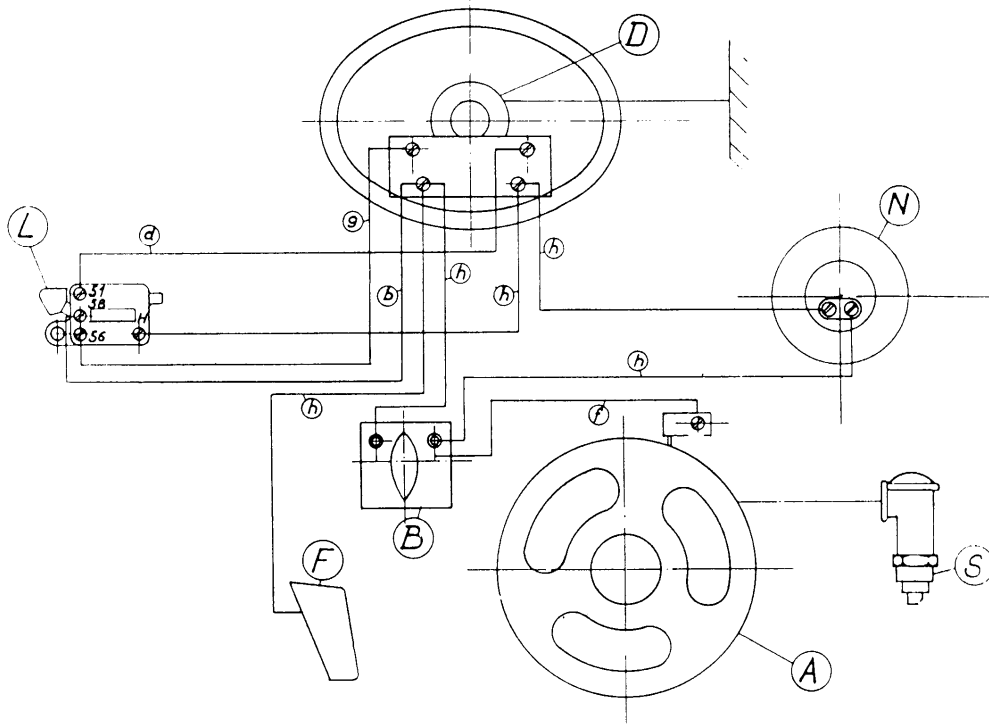

b red
 d yellow
 e white
 f blue
 g green
 h grey

A Magneto
 B HL switch
 D Head lamp
 F Tail light
 L Dimmer switch
 N Horn
 S Spark plug

QUICKLY N - S - T & TT

Technical data: Cylinder barrel	Aluminum with hardchrome plated lining. This cylinder can NOT be rebored.
Piston	5 oversizes available. Piston clearance .0006 - .001".
Carburetor N&S	Bing, Type 1/9/1, main jet 56, needle jet 210, needle position 2.
T	Bing, Type 1/12/115, main jet 54, needle jet 210, needle position 3.
TT	Bing, Type 1/12/117, main jet 56, needle jet 210, needle position 2.
End float on crankshaft012" maximum (shim up if more)
End float on transmission shafts008 - .01"
Ignition timing082" or 24° before TDC
Breaker point gap012"
Sparkplug	Bosch W 190 T 11 S
Sparkplug gap020"
Gearbox oil capacity	3 $\frac{1}{10}$ oz.
Tire pressure (appr.)	Front 22 lbs., rear 26 lbs.